



**HYDPOWER**  
HOSE & FITTINGS

**PRODUCT CATALOGUE - 2022**



TRUSTED | PROGRESSIVE | PROVEN

## RAISING THE BAR TO REDUCE YOUR PRESSURE AND COST

The Innovative B2B Wholesale Supply  
Design & Performance Specialists



## CLIENT FOCUSED PROGRAMS | OUR POINTS OF DIFFERENCE

### ADVANTAGE REWARDS™

EARN POINTS  
redeemable against  
in store credits,  
rebate scheme or  
comprehensive range  
of gift cards

### RISK FREE TRADING™

24 MONTH  
Industry leading  
no risk component  
guarantee on all  
specified items

### HYDPOWER CHALLENGE™

FREE OF CHARGE  
challenge for us to  
review & find hydraulic  
cost savings and  
performance  
improvements



**TRUSTED | PROGRESSIVE | PROVEN**

**HYDPOWER hydraulics is one of Australia's leading low cost, full-service providers**

With over 40 years of practical hands on experience, we have established ourselves as a credible trusted and strategic partner to many companies requiring hydraulic systems, components and engineering services

**OUR PROGRESSIVE APPROACH ENSURES YOU GET THE VERY BEST:**

- Competitive prices on all components
- 24 Month Risk Free Warranty
- Rewards program saving you money on purchases
- High quality and durable components
- Free technical support, unbiased advice and guidance

**HYDPOWER'S PROVEN TRACK RECORD ALLOWS US TO BE CONFIDENT IN OUR DEALINGS WITH YOU**

We are willing and able to lend a helping hand whenever you need us for :

- End to End System Design
- Component selection and supply
- Installation
- Commissioning
- Testing and troubleshooting
- Performance improvement
- System enhancement

**OUR DIVERSE HYDRAULIC EXPERIENCE INCLUDES:**

- Industrial
- Agricultural
- Construction
- Transport
- Bulk-Handling
- Recycling
- Manufacturing
- Marine

To find out how you partner with us completely risk free, visit us at [hydpower.com.au](http://hydpower.com.au)

**We look forward to adding value to your business soon**

# HOSES | HOSE END FITTINGS AND ADAPTORS

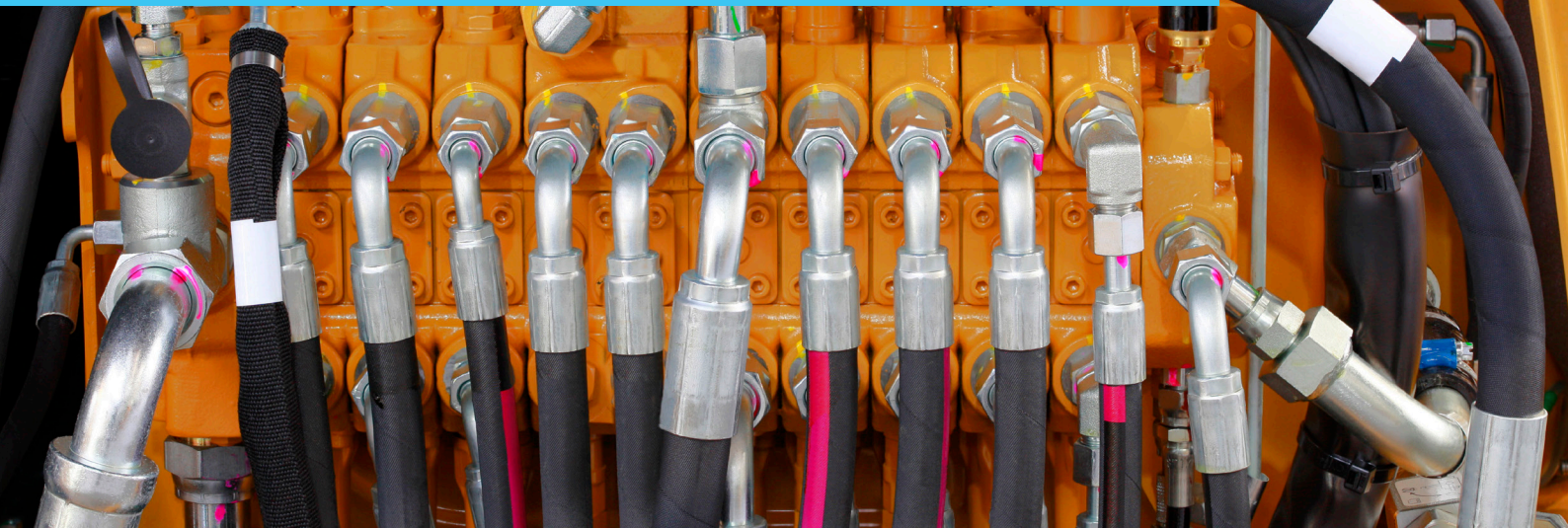

Unlike most hydraulic component suppliers, **HYDPOWER** offers a comprehensive range of high quality hoses, hose end fittings, adaptors and accessories at very competitive prices

Hoses, hose end fittings and adaptors have been strategically implemented into our business to compliment our component and design services, to provide total ownership and guarantee the best possible performance and outcomes of your hydraulic system.

In our view, it is much better to fully specify the components together simultaneously with the hose and fittings to achieve optimum system performance and reliability. Regrettably, this is a short coming within the broader hydraulics industry and a challenge for manufacturers and consumers to navigate. **HYDPOWER** takes the guess work out of this sensitive area and will assist you in selecting and specifying all of your hoses, hose end fittings and adaptors. This process will ensure that you achieve the best performance from your Hydraulics Systems.

Whether you are after a single wire, two wire, multi spiral, suction or return hose, look no further than **HYDPOWER**. Our super high quality hoses are manufactured to exceed all global hydraulic standards – thus ensuring it will provide you with reliability and long service life.

## CUSTOM BRANDING / LABELING

If you are a volume hose user, please talk to us about custom branding for your brand or product to be applied to your hydraulic hose. *Note: Minimum ordering quantities apply*

## WE OFFER A FREE \*

No obligation review and written report of your current hoses, hose end fittings and adaptors usage and/or requirements that has been specially designed to achieve the following:

- > Specification of correct hose, end fittings and adaptor types and sizes
- > Maximise efficiency / reduce losses and overheating
- > Improve performance / oil flow paths
- > Ensure correct oil operating conditions and line speeds
- > Minimise connections and potential oil leaks

\* Conditions apply, see website

# TABLE OF CONTENTS

## HOSES

PAGE 5

One Wire Smooth Coat Standard Hose .....	8	Four Wire 4K Hose .....	10
One Wire Texture Coat Standard Hose .....	8	Oil Return/Suction Hose .....	10
One Wire Smooth Coat Compact Hose .....	8	Push Lock Drain Hose .....	10
Two Wire Smooth Coat Standard Hose .....	9	One Wire Gates Smooth Coat Standard.....	12
Two Wire Texture Coat Standard Hose .....	9	Two Wire Gates Smooth Coat Standard.....	12
Two Wire Smooth Coat Compact Hose .....	9	FourWire Gates Smooth Coat Standard .....	12

## HOSE ENDS

PAGE 11

JIC Female Swivel Straight .....	16	BSPP Female Swivel Straight .....	20
JIC Female Swivel 90° Compact Elbow .....	16	BSPP Male Straight .....	20
JIC Female Swivel 90° Swept Elbow .....	17	BSPT Male Straight .....	21
JIC Female Swivel 90° Long Drop Elbow .....	17	BSPP Female Swivel 90° Compact Elbow .....	21
JIC Female Swivel 45° Swept Elbow .....	18	BSPP Female Swivel 90° Swept Elbow .....	22
JIC Male Straight .....	18	BSPP Female Swivel 45° Swept Elbow.....	22

## ADAPTORS

PAGE 23

Straight Male x Male .....	26	Reducing Bush .....	50
Straight Male x Female .....	32	Run Tee .....	53
Straight Female x Female .....	35	Branch Tee .....	55
90° Male x Male .....	38	Equal Tee .....	57
90° Male x Female .....	42	BulkHead .....	60
90° Female x Female .....	45	Nut & Sleeve .....	61
45° Male x Male .....	47	Plugs .....	61
45° Male x Female .....	49		

## ACCESSORIES

PAGE 63

Quick Release Couplings .....	70	Seals .....	74
Tube Clamps .....	72	Rings .....	75

## FULL RANGE

PAGE 75

Hose Tails .....	78	Adaptors .....	82
------------------	----	----------------	----

## TECHNICAL INFO

PAGE 91

Quick Conversion Table .....	94	Assembly Length & Angular Orientation .....	97
Pressure Drop Chart .....	95	Connector Pressure Tables .....	98
Fluid Nomograph .....	96	Crimp Charts .....	100

# ALL IN ONE KITTING PROGRAM

If production of machines is your business, then our **HYDPOWER 'ALL IN 1'** Kitting Program is just the thing for you

We work with you to establish your particular needs – then review and document your systems to provide you with the best performance and cost saving changes.

Once identified, we can provide you with a simple re-order process with one part number covering every item that makes up each of your complete set of hoses and adaptors. This time saving initiative is just one of the many ways we are able to help your business operate more efficiently.

## BUILD YOUR PROGRAM

Alternatively, if you prefer to make up your own hose assemblies, our hoses can be simply sold by the metre or a full reel. The hose end fittings and adaptors can be reordered on a monthly or weekly Kanban System to ensure you have the stock you require – the choice is entirely yours.

## STORAGE SYSTEM

We offer a flexible storage system to help you keep all of your hose ends & adaptors neatly organised in labelled bins. This great mobile unit can be wheeled to just about any position in your workshop close to where your product assembly area is. Once your stock get low, simply re-order using our **new online business to business portal**. Contact us today for further information.

## CRIMPING MACHINES AND DIAMOND CUT OFF SAWS

We can also supply an extensive range of **HYDCRIMP**- Crimping Machines and Diamond Cut Off Saws to suit your business and budget.

Components, Hose and Fittings all under one roof and just a call away. Contact **HYDPOWER** today for all of your hydraulic needs.

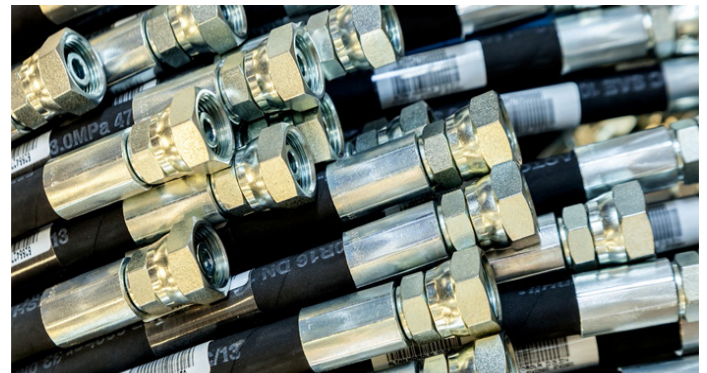

# STANDARD HOSES

# CODING SYSTEM

## Hydraulic Hose

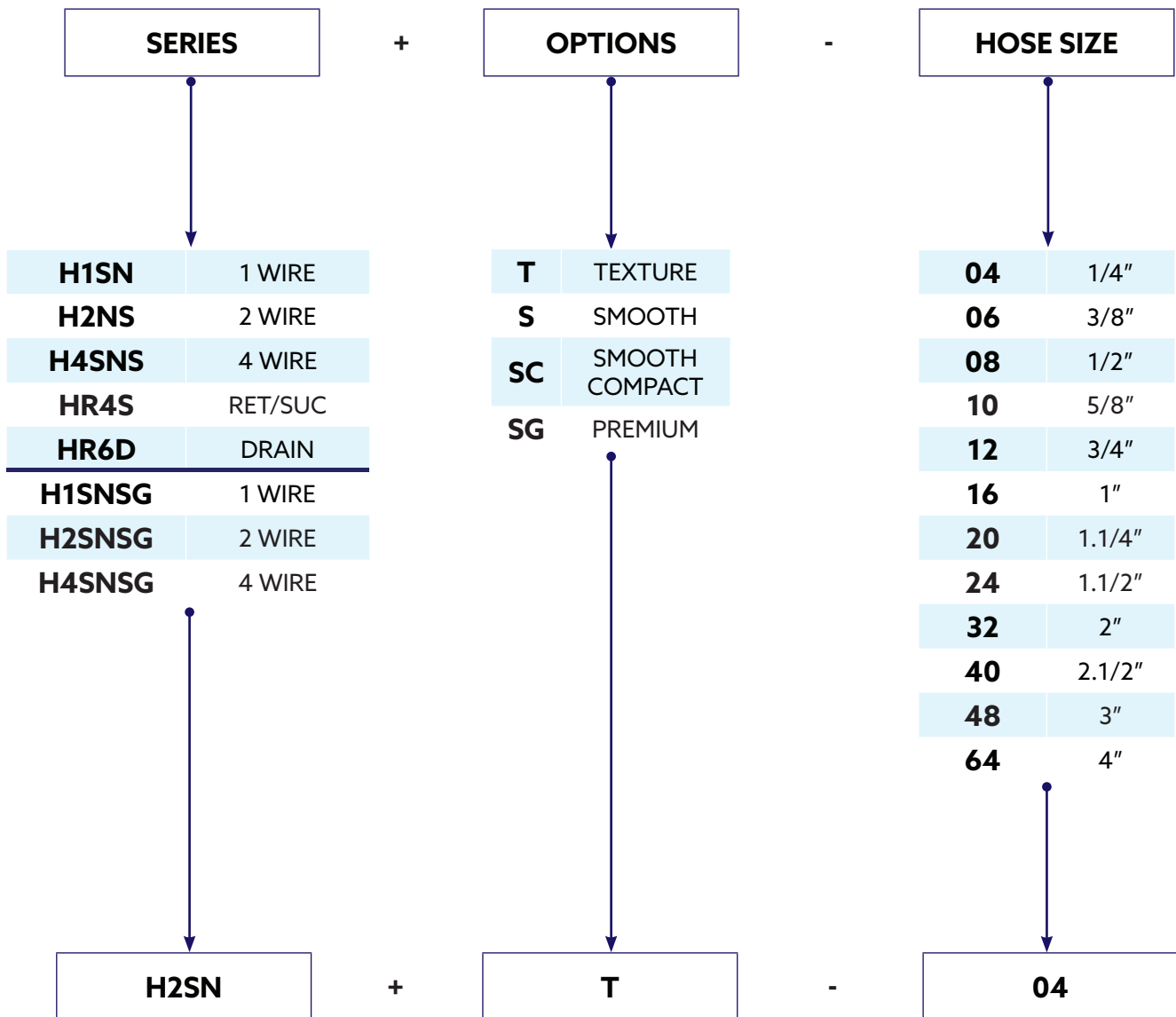

EXAMPLE  
**H2SNT-04**  
 HOSE TWO WIRE  
 Texture coat, 1/4 Hose



### STANDARD HOSES

ONE WIRE  
SMOOTH COAT STANDARD



Page 8

ONE WIRE  
TEXTURE COAT STANDARD



Page 8

ONE WIRE  
SMOOTH COAT COMPACT



Page 8

TWO WIRE  
SMOOTH COAT STANDARD



Page 9

TWO WIRE  
TEXTURE COAT STANDARD



Page 9

TWO WIRE  
SMOOTH COAT COMPACT



Page 9

FOUR WIRE  
4K HOSE



Page 10

OIL RETURN / SUCTION  
HOSE



Page 10

PUSH LOCK  
DRAIN HOSE



Page 10

### PREMIUM HOSES

ONE WIRE - GATES  
SMOOTH COAT STANDARD



Page 12

TWO WIRE - GATES  
SMOOTH COAT STANDARD



Page 12

FOUR WIRE - GATES  
SMOOTH COAT STANDARD



Page 12

*For other hoses please contact us*

## STANDARD HYDRAULIC HOSE - 1 WIRE

### Smooth Coat - Standard

**Specifications:** SAE 100R1AT & EN853 1SN / DIN

**Tube:** Black NBR (Nitrile) synthetic rubber

**Reinforcement:** One braid of high tensile steel wire

**Cover:** Black oil and abrasion resistant synthetic rubber

**Temperature Range:** -40° C to +100° C



Part Number	Size	WP PSI	Max WP Bar	Coil Length (M)	List Price (P/M) (\$)
H1SNS-04	1/4"	3275	225	POA	12.90
H1SNS-06	3/8"	2600	180	POA	15.06
H1SNS-08	1/2"	2325	160	POA	19.38
H1SNS-10	5/8"	1850	130	POA	21.54
H1SNS-12	3/4"	1525	105	POA	23.70
H1SNS-16	1"	1275	88	POA	33.42

## STANDARD HYDRAULIC HOSE - 1 WIRE

### Texture Coat - Standard

**Specifications:** SAE 100 R1AT & EN853 1SN / DIN

**Tube:** Black NBR (Nitrile) synthetic rubber

**Reinforcement:** One braid of high tensile steel wire

**Cover:** Black oil and abrasion resistant synthetic rubber

**Temperature Range:** -40° C to +100° C



Part Number	Size	WP PSI	Max WP Bar	Coil Length (M)	List Price (P/M) (\$)
H1SNT-04	1/4"	3275	225	POA	12.90
H1SNT-06	3/8"	2600	180	POA	15.06
H1SNT-08	1/2"	2325	160	POA	19.38
H1SNT-10	5/8"	1900	130	POA	21.54
H1SNT-12	3/4"	1525	105	POA	23.70
H1SNT-16	1"	1275	88	POA	33.42

## STANDARD HYDRAULIC HOSE - 1 WIRE

### Smooth Coat - Compact

**Specifications:** SAE 100R1AT & EN853 1SN / DIN

**Tube:** Black NBR (Nitrile) synthetic rubber

**Reinforcement:** One braid of high tensile steel wire

**Cover:** Black oil and abrasion resistant synthetic rubber

**Temperature Range:** -40° C to +100° C



Part Number	Size	WP PSI	Max WP Bar	Coil Length (M)	List Price (P/M) (\$)
H1SNS-04	1/4"	3275	225	POA	13.73
H1SNS-06	3/8"	2600	180	POA	16.03
H1SNS-08	1/2"	2325	160	POA	20.63
H1SNS-10	5/8"	1850	130	POA	23.17
H1SNS-12	3/4"	1525	105	POA	25.23
H1SNS-16	1"	1275	88	POA	39.58

## STANDARD HYDRAULIC HOSE - 2 WIRE

### Smooth Coat - Standard

**Specifications:** SAE 100 R1AT & EN853 1SN / DIN

**Tube:** Black NBR (Nitrile) synthetic rubber

**Reinforcement:** One braid of high tensile steel wire

**Cover:** Black oil and abrasion resistant synthetic rubber

**Temperature Range:** -40° C to +100° C



Part Number	Size	WP PSI	Max WP Bar	Coil Length (M)	List Price (P/M) (\$)
H2SNS-04	1/4"	5800	400	50/100	15.06
H2SNS-06	3/8"	4785	330	50/100	18.3
H2SNS-08	1/2"	4000	275	50/100	20.46
H2SNS-10	5/8"	3625	250	50/100	25.86
H2SNS-12	3/4"	3100	215	50/100	29.1
H2SNS-16	1"	2400	165	50/100	40.98

## STANDARD HYDRAULIC HOSE - 2 WIRE

### Texture Coat - Standard

**Specifications:** SAE 100 R2AT & EN853 2SN / DIN

**Tube:** Black NBR (Nitrile) synthetic rubber

**Reinforcement:** Two braids of high tensile steel wire

**Cover:** Black oil and abrasion resistant synthetic rubber

**Temperature Range:** -40° C to +100° C



Part Number	Size	WP PSI	Max WP Bar	Coil Length (M)	List Price (P/M) (\$)
H2SNT-04	1/4"	5800	400	POA	15.06
H2SNT-06	3/8"	4785	330	POA	18.3
H2SNT-08	1/2"	4000	275	POA	20.46
H2SNT-10	5/8"	3685	250	POA	25.86
H2SNT-12	3/4"	3100	215	POA	29.1
H2SNT-16	1"	2400	165	POA	40.98
H2SNT-20	1.1/4"	1825	125	50/100	67.98
H2SNT-24	1.1/2"	1300	90	50/100	96.06
H2SNT-32	2"	1175	80	50/100	107.83

## STANDARD HYDRAULIC HOSE - 2 WIRE

### Smooth Coat - Compact

**Specifications:** SAE 100 R16 & EN857 2SC / DIN

**Tube:** Black NBR (Nitrile) synthetic rubber

**Reinforcement:** Two braids of high tensile steel wire

**Cover:** Black oil and abrasion resistant synthetic rubber

**Temperature Range:** -40° C to +100° C



Part Number	Size	WP PSI	Max WP Bar	Coil Length (M)	List Price (P/M) (\$)
H2SNF-04	1/4"	5800	400	50/100	15.06
H2SNF-06	3/8"	4785	330	50/100	23.04
H2SNF-08	1/2"	4000	275	50/100	20.46
H2SNF-10	5/8"	3625	250	50/100	25.86
H2SNF-12	3/4"	3100	215	50/100	29.1
H2SNF-16	1"	2400	165	50/100	40.98

## STANDARD HYDRAULIC HOSE - 4 WIRE

### Texture Coat - Standard

**Specifications:** SAE 100 R2AT & EN853 2SN / DIN

**Tube:** Black NBR (Nitrile) synthetic rubber

**Reinforcement:** Two braids of high tensile steel wire

**Cover:** Black oil and abrasion resistant synthetic rubber

**Temperature Range:** -40° C to +100° C



Part Number	Size	WP Bar	Max WP Bar	Coil Length (M)	List Price (P/M) (\$)
H4SNS-06	3/8"	280	1120	POA	56.90
H4SNS-08	1/2"	280	1120	POA	60.36
H4SNS-10	5/8"	280	1120	POA	65.91
H4SNS-12	3/4"	280	1120	POA	69.38
H4SNS-16	1"	280	1120	POA	86.84

## STANDARD HYDRAULIC HOSE - OIL RETURN / SUCTION

### Texture Coat - Standard

**Specifications:** Suitable for oil in both suction and discharge

**Tube:** Black smooth nitrile compound and fuel & oil resistance

**Reinforcement:** High tensile polyester braid plus wire helix

**Cover:** Black wrapped and abrasion resistant synthetic rubber

**Temperature Range:** -20° C to +100° C

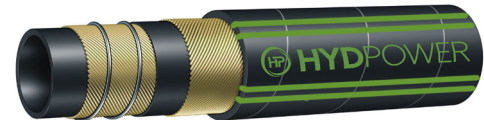

Part Number	Size	WP Bar	Max WP Bar	Coil Length (M)	List Price (P/M) (\$)
HR4S-12	3/4"	10	30	POA	32.72
HR4S-16	1"	10	30	POA	38.76
HR4S-20	1.1/4"	10	30	POA	43.32
HR4S-24	1.1/2"	10	30	POA	48.84
HR4S-32	2"	10	30	POA	66.48
HR4S-40	2.1/2"	10	30	POA	98.84
HR4S-48	3"	10	30	POA	110.68

## STANDARD HYDRAULIC HOSE - PUSH LOCK DRAIN

### Texture Coat - Standard

**Specifications:** High quality push lock drain hose

**Tube:** Synthetic oil resistant rubber

**Reinforcement:** 1 textile braids

**Cover:** Synthetic rubber - abrasion, ozone and weather resistant

**Temperature Range:** -40° C to +120° C



Part Number	Size	WP Bar	Max WP Bar	Coil Length (M)	List Price (P/M) (\$)
HR6D-04	1/4"	28	110	POA	18.92
HR6D-06	3/8"	28	110	POA	24.10
HR6D-08	1/2"	28	110	POA	26.87
HR6D-12	3/4"	21	83	POA	37.37
HR6D-16	1"	13	52	POA	43.29

# PREMIUM HOSES



## PREMIUM HYDRAULIC HOSE - 1 WIRE

### Smooth Coat - Standard

**Specifications:** SAE 100R10 - EN 856 4SP

**Tube:** Black NBR (Nitrile) synthetic rubber

**Reinforcement:** Four spiral layers high tensile steel wire

**Cover:** Black oil and abrasion resistant synthetic rubber

**Temperature Range:** -40° C to +100° C



Part Number	Size	WP PSI	Max WP Bar	Coil Length (M)	List Price (P/M) (\$)
H1SNSG-04	1/4"	2600	860	167	13.73
H1SNSG-06	3/8"	2600	860	121	16.03
H1SNSG-08	1/2"	2600	860	100	20.63
H1SNSG-10	5/8"	2600	860	67	23.17
H1SNSG-12	3/4"	2600	860	POA	25.23
H1SNSG-16	1"	2600	860	POA	39.58

## PREMIUM HYDRAULIC HOSE - 2 WIRE

### Smooth Coat - Standard

**Specifications:** SAE 100R10 - EN 856 4SH

**Tube:** Black NBR (Nitrile) synthetic rubber

**Reinforcement:** Four spiral layers high tensile steel wire

**Cover:** Black oil and abrasion resistant synthetic rubber

**Temperature Range:** -40° C to +100° C



Part Number	Size	WP PSI	Max WP Bar	Coil Length (M)	List Price (P/M) (\$)
H2SNSG-04	1/4"	4800	330	167	16.03
H2SNSG-06	3/8"	4800	330	121	19.48
H2SNSG-08	1/2"	4800	330	100	21.78
H2SNSG-10	5/8"	4800	330	67	25.86
H2SNSG-12	3/4"	4800	330	67	30.98
H2SNSG-16	1"	4800	330	50	43.63

## PREMIUM HYDRAULIC HOSE - 4 WIRE

### Texture Coat - Standard

**Specifications:** SAE 100R4

**Tube:** Black NBR (Nitrile) synthetic rubber

**Reinforcement:** High tensile textile cords with embedded steel helix wire

**Cover:** Black oil and abrasion resistant synthetic rubber

**Temperature Range:** -40° C to +100° C



Part Number	Size	WP PSI	Max WP Bar	Coil Length (M)	List Price (P/M) (\$)
H4SNSG-06	3/8"	4000	275	91	60.39
H4SNSG-08	1/2"	"	"	70	64.07
H4SNSG-12	3/4"	4000	275	61	73.64
H4SNSG-16	1"	"	"	40	92.18

# HOSE ENDS

# CODING SYSTEM

## Hose Ends

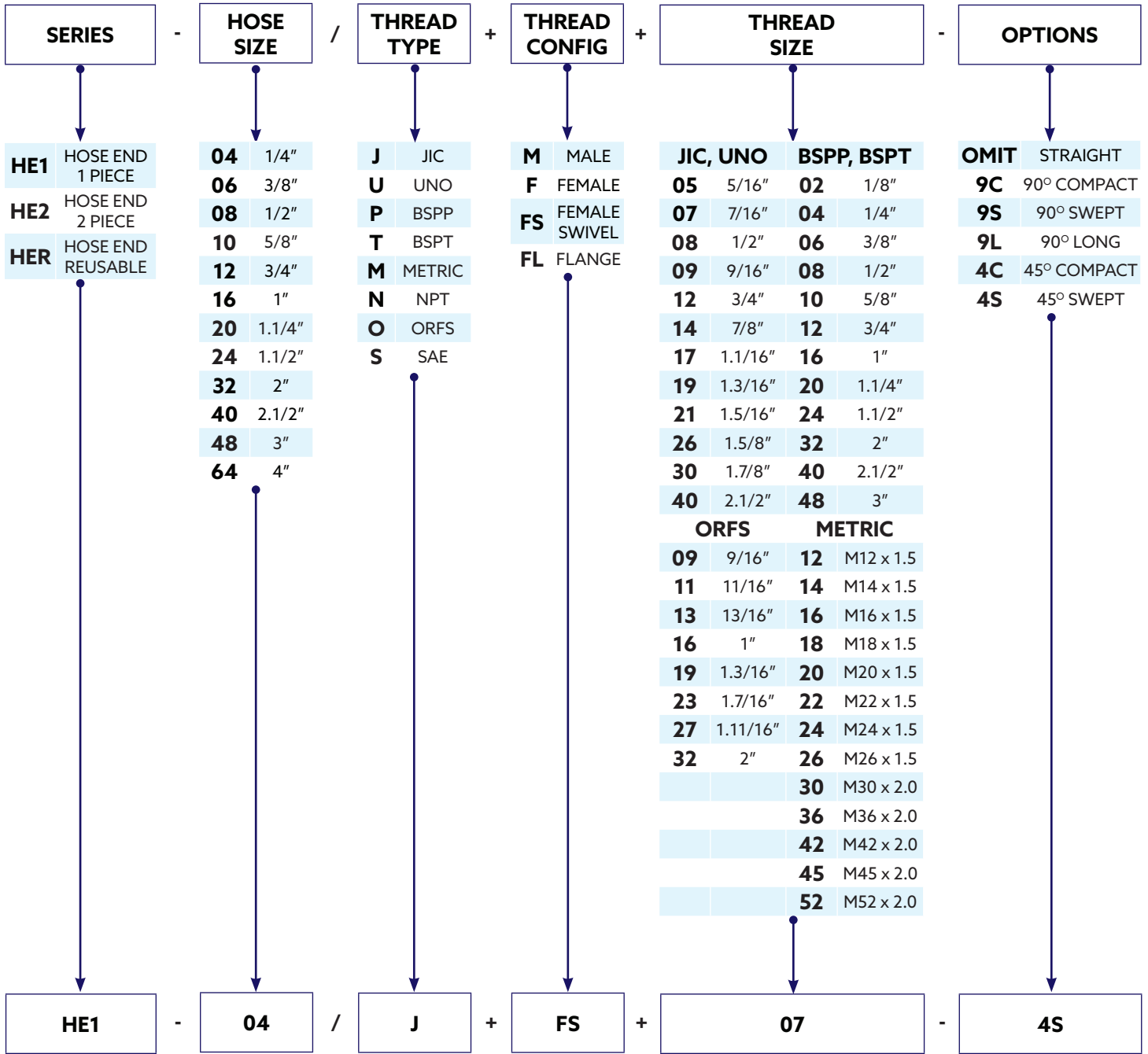

Example  
**HE1-04/JFS07-4S**  
**ONE PIECE - 1/4" Hose, JIC Female Swivel 45° Swept Elbow**



JIC FEMALE SWIVEL  
STRAIGHT

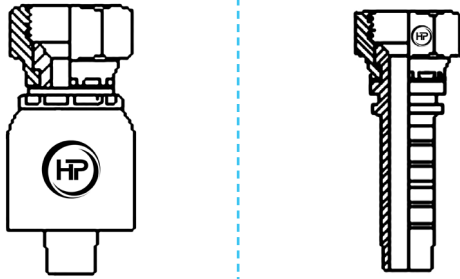

Page 16

JIC FEMALE SWIVEL  
90° COMPACT

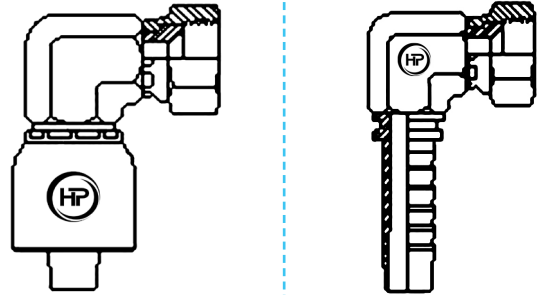

Page 16

JIC FEMALE SWIVEL  
90° SWEPT

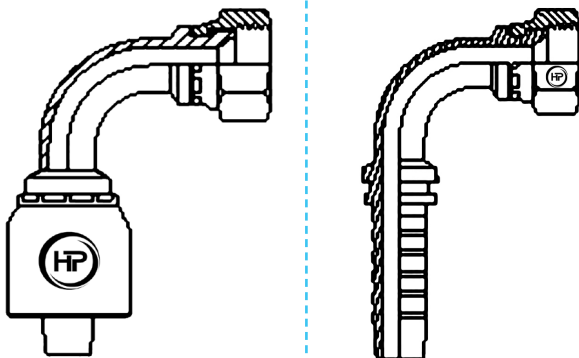

Page 17

JIC FEMALE SWIVEL  
90° LONG DROP

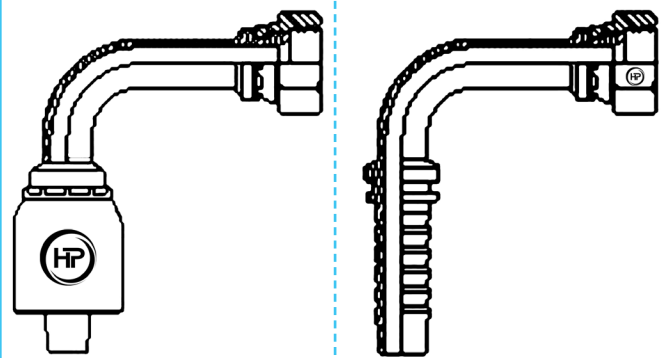

Page 17

JIC FEMALE SWIVEL  
45° SWEPT

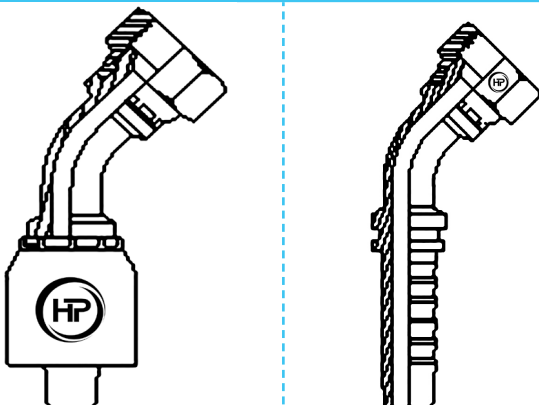

Page 18

JIC MALE  
STRAIGHT

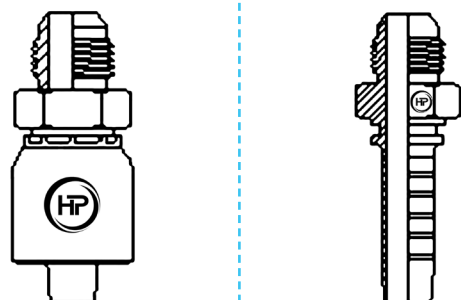

Page 18

*For other sizes and thread types please contact us*

## JIC HOSE END - STRAIGHT

### JIC Female Swivel Straight, Suitable for 1 & 2 Wire

\*Two piece price includes Ferrule

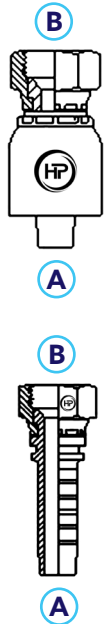

Part Number		Hose	JIC	List price (\$)	
One Piece	Two Piece	(A)	(B)	One Piece	Two Piece
HE1-04/JFS07	HE2-04/JFS07	1/4"	7/16"	12.27	11.21
HE1-04/JFS08	HE2-04/JFS08	1/4"	1/2"	17.82	14.22
HE1-04/JFS09	HE2-04/JFS09	1/4"	9/16"	12.25	11.80
HE1-05/JFS09	HE2-05/JFS09	5/16"	9/16"	POA	17.77
HE1-06/JFS09	HE2-06/JFS09	3/8"	9/16"	13.99	13.40
HE1-08/JFS09	HE2-08/JFS09	1/2"	9/16"	POA	17.17
HE1-04/JFS12	HE2-04/JFS12	1/4"	3/4"	18.26	17.13
HE1-06/JFS12	HE2-06/JFS12	3/8"	3/4"	7.44	14.20
HE1-08/JFS12	HE2-08/JFS12	1/2"	3/4"	18.09	15.66
HE1-10/JFS12	HE2-10/JFS12	5/8"	3/4"	POA	25.57
HE1-06/JFS14	HE2-06/JFS14	3/8"	7/8"	23.4	19.84
HE1-08/JFS14	HE2-08/JFS14	1/2"	7/8"	19.12	17.20
HE1-10/JFS14	HE2-10/JFS14	5/8"	7/8"	27.18	28.43
HE1-12/JFS14	HE2-12/JFS14	3/4"	7/8"	POA	27.80
HE1-08/JFS17	HE2-08/JFS17	1/2"	1.1/16"	31.08	26.41
HE1-10/JFS17	HE2-10/JFS17	5/8"	1.1/16"	31.33	30.80
HE1-12/JFS17	HE2-12/JFS17	3/4"	1.1/16"	28.64	28.63
HE1-16/JFS17	HE2-16/JFS17	1"	1.1/16"	47.52	50.25
HE1-12/JFS19	HE2-12/JFS19	3/4"	1.3/16"	POA	42.17
HE1-12/JFS21	HE2-12/JFS21	3/4"	1.5/16"	53.90	62.73
HE1-16/JFS21	HE2-16/JFS21	1"	1.5/16"	47.04	43.64
HE1-16/JFS26	HE2-16/JFS26	1"	1.5/8"	POA	64.39
HE1-20/JFS26	HE2-20/JFS26	1.1/4"	1.5/8"	POA	81.05
HE1-20/JFS30	HE2-20/JFS30	1.1/4"	1.7/8"	POA	101.25
HE1-24/JFS30	HE2-24/JFS30	1.1/2"	1.7/8"	POA	109.02
HE1-32/JFS40	HE2-32/JFS40	2"	2.1/2"	POA	231.62

## JIC HOSE END - 90° COMPACT

### JIC Female Swivel 90° Compact Elbow, Suitable for 1 & 2 Wire

\*Two piece price includes Ferrule

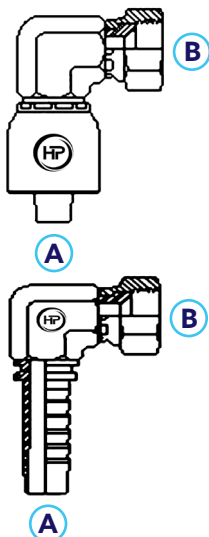

Part Number		Hose	JIC	List price (\$)	
One Piece	Two Piece	(A)	(B)	One Piece	Two Piece
HE1-04/JFS07-9C	HE2-04/JFS07-9C	1/4"	7/16"	34.31	26.96
HE1-04/JFS08-9C	HE2-04/JFS08-9C	1/4"	1/2"	POA	42.26
HE1-04/JFS09-9C	HE2-04/JFS09-9C	1/4"	9/16"	33.33	27.67
HE1-06/JFS09-9C	HE2-06/JFS09-9C	3/8"	9/16"	32.05	29.92
HE1-06/JFS12-9C	HE2-06/JFS12-9C	3/8"	3/4"	33.64	32.38
HE1-08/JFS12-9C	HE2-08/JFS12-9C	1/2"	3/4"	41.85	37.28
HE1-08/JFS14-9C	HE2-08/JFS14-9C	1/2"	7/8"	42.63	41.00
HE1-08/JFS17-9C	HE2-08/JFS17-9C	1/2"	1.1/16"	POA	50.23
HE1-12/JFS17-9C	HE2-12/JFS17-9C	3/4"	1.1/16"	60.03	58.45
HE1-16/JFS21-9C	HE2-16/JFS21-9C	1"	1.5/16"	87.93	95.03

## HOSE END - 90° SWEPT

### JIC Female Swivel 90° Swept Elbow, Suitable for 1 & 2 Wire

\*Two piece price includes Ferrule

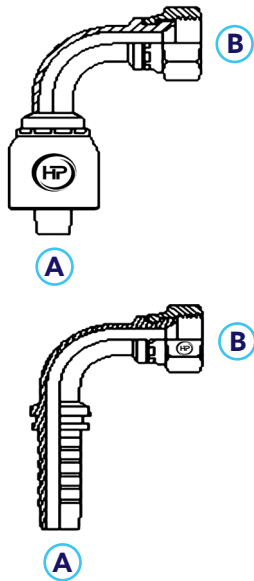

Part Number		Hose	JIC	List price (\$)	
One Piece	Two Piece	(A)	(B)	One Piece	Two Piece
HE1-04/JFS07-9S	HE2-04/JFS07-9S	1/4"	7/16"	26.32	27.96
HE1-04/JFS08-9S	HE2-04/JFS08-9S	1/4"	1/2"	41.53	30.50
HE1-04/JFS09-9S	HE2-04/JFS09-9S	1/4"	9/16"	27.86	28.89
HE1-06/JFS09-9S	HE2-06/JFS09-9S	3/8"	9/16"	29.51	29.80
HE1-04/JFS12-9S	HE2-04/JFS12-9S	1/4"	3/4"	37.42	36.56
HE1-06/JFS12-9S	HE2-06/JFS12-9S	3/8"	3/4"	30.81	31.10
HE1-08/JFS12-9S	HE2-08/JFS12-9S	1/2"	3/4"	33.60	34.48
HE1-06/JFS14-9S	HE2-06/JFS14-9S	3/8"	7/8"	53.70	40.46
HE1-08/JFS14-9S	HE2-08/JFS14-9S	1/2"	7/8"	35.23	44.17
HE1-10/JFS14-9S	HE2-10/JFS14-9S	5/8"	7/8"	44.28	46.76
HE1-12/JFS14-9S	HE2-12/JFS14-9S	3/4"	7/8"	75.98	75.56
HE1-08/JFS17-9S	HE2-08/JFS17-9S	1/2"	1.1/16"	71.04	57.00
HE1-10/JFS17-9S	HE2-10/JFS17-9S	5/8"	1.1/16"	56.53	54.3
HE1-12/JFS17-9S	HE2-12/JFS17-9S	3/4"	1.1/16"	49.23	51.82
HE1-12/JFS19-9S	HE2-12/JFS19-9S	3/4"	1.3/16"	POA	98.31
HE1-12/JFS21-9S	HE2-12/JFS21-9S	3/4"	1.5/16"	POA	87.88
HE1-16/JFS21-9S	HE2-16/JFS21-9S	1"	1.5/16"	96.65	80.21
HE1-16/JFS26-9S	HE2-16/JFS26-9S	1"	1.5/8"	POA	106.13
HE1-20/JFS26-9S	HE2-20/JFS26-9S	1.1/4"	1.5/8"	POA	159.22
HE1-24/JFS30-9S	HE2-24/JFS30-9S	1.1/2"	1.7/8"	POA	235.45
HE1-32/JFS40-9S	HE2-32/JFS40-9S	2"	2.1/2"	POA	568.3

## HOSE END - 90° LONG DROP

### JIC Female Swivel 90° Long Drop Elbow, Suitable for 1 & 2 Wire

\*Two piece price includes Ferrule

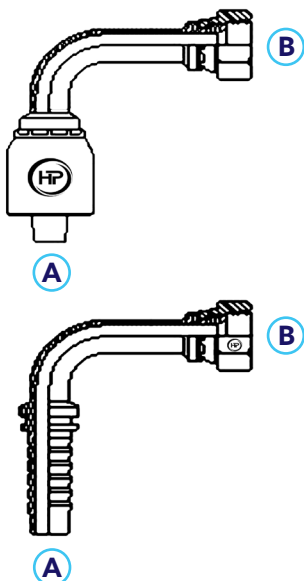

Part Number		Hose	JIC	List price (\$)	
One Piece	Two Piece	(A)	(B)	One Piece	Two Piece
HE1-04/JFS07-9L	HE2-04/JFS07-9L	1/4"	7/16"	POA	31.38
HE1-04/JFS09-9L	HE2-04/JFS09-9L	1/4"	9/16"	48.11	23.90
HE1-06/JFS09-9L	HE2-06/JFS09-9L	3/8"	9/16"	47.67	42.39
HE1-06/JFS12-9L	HE2-06/JFS12-9L	3/8"	3/4"	49.63	43.70
HE1-08/JFS12-9L	HE2-08/JFS12-9L	1/2"	3/4"	54.56	45.31
HE1-08/JFS14-9L	HE2-08/JFS14-9L	1/2"	7/8"	POA	49.62
HE1-10/JFS14-9L	HE2-10/JFS14-9L	5/8"	7/8"	POA	61.28
HE1-12/JFS17-9L	HE2-12/JFS17-9L	3/4"	1.1/16"	79.50	73.41
HE1-16/JFS21-9L	HE2-16/JFS21-9L	1"	1.5/16"	117.76	105.01

## HOSE END - 45° ELBOW

### JIC Female Swivel 45° Swept Elbow, Suitable for 1 & 2 Wire

\*Two piece price includes Ferrule

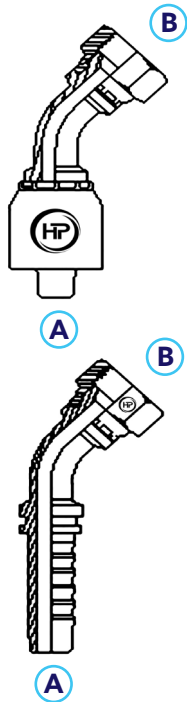

Part Number		Hose	JIC	List price (\$)	
One Piece	Two Piece	A	B	One Piece	Two Piece
HE1-04/JFS07-4S	HE2-04/JFS07-4S	1/4"	7/16"	27.25	29.37
HE1-04/JFS08-4S	HE2-04/JFS08-4S	1/4"	1/2"	42.97	40.06
HE1-04/JFS09-4S	HE2-04/JFS09-4S	1/4"	9/16"	29.74	31.95
HE1-06/JFS09-4S	HE2-06/JFS09-4S	3/8"	9/16"	32.21	35.88
HE1-06/JFS12-4S	HE2-06/JFS12-4S	3/8"	3/4"	32.83	34.13
HE1-08/JFS12-4S	HE2-08/JFS12-4S	1/2"	3/4"	34.65	35.50
HE1-08/JFS14-4S	HE2-08/JFS14-4S	1/2"	7/8"	37.57	39.54
HE1-10/JFS14-4S	HE2-10/JFS14-4S	5/8"	7/8"	41.60	47.14
HE1-08/JFS17-4S	HE2-08/JFS17-4S	1/2"	1.1/16"	POA	61.10
HE1-10/JFS17-4S	HE2-10/JFS17-4S	1/2"	1.1/16"	52.69	53.56
HE1-12/JFS17-4S	HE2-12/JFS17-4S	3/4"	1.1/16"	50.79	55.43
HE1-12/JFS19-4S	HE2-12/JFS19-4S	3/4"	1.3/16"	POA	92.43
HE1-12/JFS21-4S	HE2-12/JFS21-4S	3/4"	1.5/16"	POA	93.32
HE1-16/JFS21-4S	HE2-16/JFS21-4S	1"	1.5/16"	77.58	83.56
HE1-20/JFS26-4S	HE2-20/JFS26-4S	1.1/4"	1.5/8"	POA	157.63
HE1-24/JFS30-4S	HE2-24/JFS30-4S	1.1/2"	1.7/8"	POA	253.59
HE1-32/JFS40-4S	HE2-32/JFS40-4S	2"	2.1/2"	POA	746.26

## HOSE END - STRAIGHT

### JIC Male Straight, Suitable for 1 & 2 Wire

\*Two piece price includes Ferrule



Part Number		Hose	JIC	List price (\$)	
One Piece	Two Piece	A	B	One Piece	Two Piece
HE1-04/JM07	HE2-04/JM07	1/4"	7/16"	13.85	16.74
HE1-04/JM08	HE2-04/JM08	1/4"	1/2"	19.60	17.22
HE1-04/JM09	HE2-04/JM09	1/4"	9/16"	12.50	16.03
HE1-06/JM09	HE2-06/JM09	3/8"	9/16"	14.25	16.25
HE1-04/JM12	HE2-04/JM12	1/4"	3/4"	POA	37.03
HE1-06/JM12	HE2-06/JM12	3/8"	3/4"	16.35	19.16
HE1-08/JM12	HE2-08/JM12	1/2"	3/4"	17.61	19.87
HE1-06/JM14	HE2-06/JM14	3/8"	7/8"	20.50	20.65
HE1-08/JM14	HE2-08/JM14	1/2"	7/8"	19.63	20.92
HE1-10/JM14	HE2-10/JM14	5/8"	7/8"	22.85	29.47
HE1-12/JM14	HE2-12/JM14	3/4"	7/8"	POA	38.99
HE1-08/JM17	HE2-08/JM17	1/2"	1.1/16"	POA	30.96
HE1-10/JM17	HE2-10/JM17	5/8"	1.1/16"	25.16	35.97
HE1-12/JM17	HE2-12/JM17	3/4"	1.1/16"	27.50	32.40
HE1-12/JM21	HE2-12/JM21	3/4"	1.5/16"	48.80	47.16
HE1-16/JM21	HE2-16/JM21	1"	1.5/16"	44.06	52.29
HE1-16/JM26	HE2-16/JM26	1"	1.5/8"	POA	84.46
HE1-20/JM26	HE2-20/JM26	1.1/4"	1.5/8"	POA	104.64
HE1-24/JM30	HE2-24/JM30	1.1/2"	1.7/8"	POA	202.68
HE1-32/JM40	HE2-32/JM40	2"	2.1/2"	POA	410.41

### BSP FEMALE SWIVEL STRAIGHT

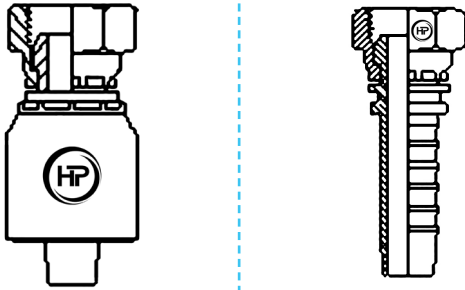

Page 20

### BSP MALE STRAIGHT

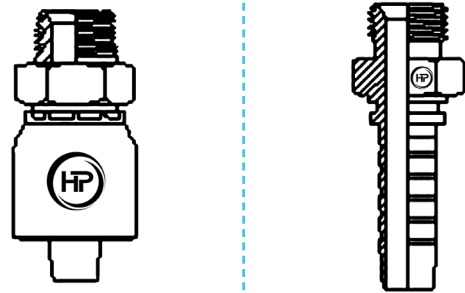

Page 20

### BSPT MALE STRAIGHT

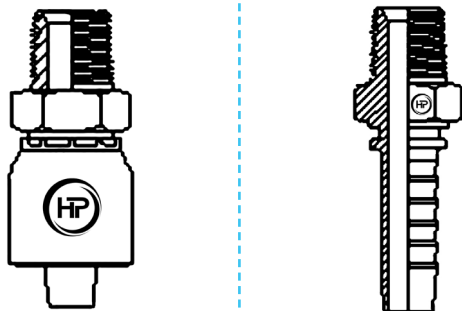

Page 20

### BSP FEMALE SWIVEL 90° COMPACT

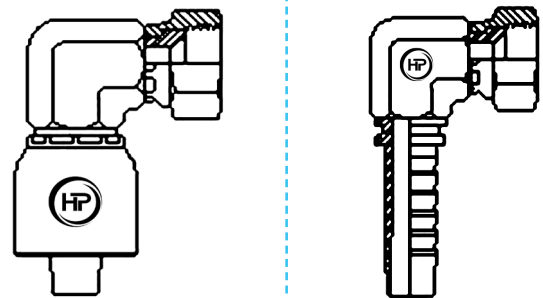

Page 20

### BSP FEMALE SWIVEL 90° SWEPT

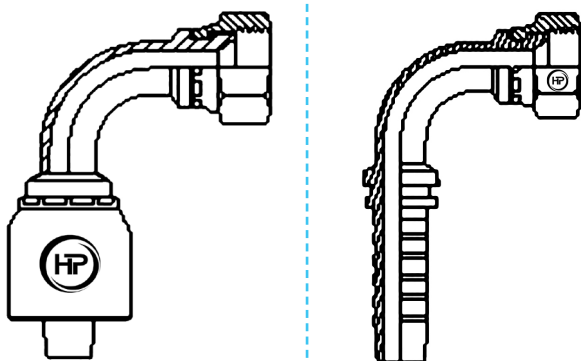

Page 22

### BSP FEMALE SWIVEL 45° SWEPT

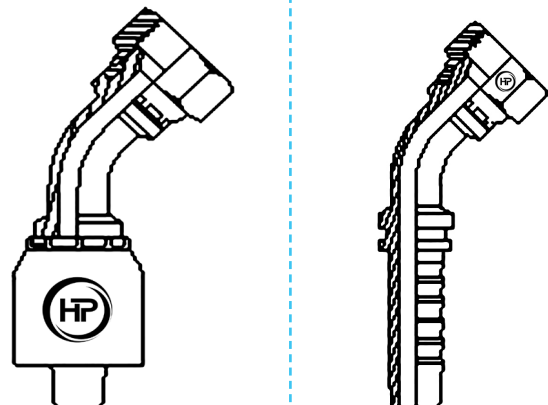

Page 22

*For other sizes and thread types please contact us*

## HOSE END - STRAIGHT

### BSPF Female Swivel Straight, Suitable for 1 & 2 Wire

\*Two piece price includes Ferrule

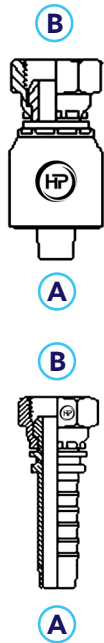

Part Number		Hose	BSPF	List price (\$)	
One Piece	Two Piece	A	B	One Piece	Two Piece
HE1-04/PFS02	HE2-04/PFS02	1/4"	1/8"	16.72	14.63
HE1-04/PFS04	HE2-04/PFS04	1/4"	1/4"	13.32	12.52
HE1-06/PFS04	HE2-06/PFS04	3/8"	1/4"	POA	17.09
HE1-04/PFS06	HE2-04/PFS06	1/4"	3/8"	17.60	18.32
HE1-06/PFS06	HE2-06/PFS06	3/8"	3/8"	14.26	13.01
HE1-08/PFS06	HE2-08/PFS06	1/2"	3/8"	25.46	19.87
HE1-06/PFS08	HE2-06/PFS08	3/8"	1/2"	20.70	16.10
HE1-08/PFS08	HE2-08/PFS08	1/2"	1/2"	20.57	16.66
HE1-10/PFS08	HE2-10/PFS08	5/8"	1/2"	36.47	27.71
HE1-08/PFS10	HE2-08/PFS10	1/2"	5/8"	POA	26.88
HE1-10/PFS10	HE2-10/PFS10	5/8"	5/8"	POA	35.08
HE1-08/PFS12	HE2-08/PFS12	1/2"	3/4"	32.24	40.13
HE1-10/PFS12	HE2-10/PFS12	5/8"	3/4"	POA	44.88
HE1-12/PFS12	HE2-12/PFS12	3/4"	3/4"	27.91	28.27
HE1-12/PFS16	HE2-12/PFS16	3/4"	1"	60.83	60.89
HE1-16/PFS16	HE2-16/PFS16	1"	1"	50.49	48.32
HE1-16/PFS20	HE2-16/PFS20	1"	1.1/4"	POA	72.27
HE1-20/PFS20	HE2-20/PFS20	1.1/4"	1.1/4"	POA	110.34
HE1-20/PFS24	HE2-20/PFS24	1.1/4"	1.1/2"	POA	168.85
HE1-24/PFS24	HE2-24/PFS24	1.1/2"	1.1/2"	POA	153.62
HE1-32/PFS32	HE2-32/PFS32	2"	2"	50.49	289.65

## HOSE END - STRAIGHT

### BSPF Male Straight, Suitable for 1 & 2 Wire

\*Two piece price includes Ferrule



Part Number		Hose	BSPF	List price (\$)	
One Piece	Two Piece	A	B	One Piece	Two Piece
HE1-04/PM02	HE2-04/PM02	1/4"	1/8"	POA	19.27
HE1-04/PM04	HE2-04/PM04	1/4"	1/4"	POA	13.71
HE1-04/PM06	HE2-04/PM06	1/4"	3/8"	POA	15.84
HE1-06/PM06	HE2-06/PM06	3/8"	3/8"	17.46	18.30
HE1-08/PM06	HE2-08/PM06	1/2"	3/8"	POA	22.72
HE1-06/PM08	HE2-06/PM08	3/8"	1/2"	24.66	19.43
HE1-08/PM08	HE2-08/PM08	1/2"	1/2"	21.27	19.44
HE1-08/PM12	HE2-08/PM12	1/2"	3/4"	POA	36.57
HE1-10/PM12	HE2-10/PM12	5/8"	3/4"	POA	42.92
HE1-12/PM12	HE2-12/PM12	3/4"	3/4"	POA	34.04
HE1-12/PM16	HE2-12/PM16	3/4"	1"	POA	58.51
HE1-16/PM16	HE2-16/PM16	1"	1"	POA	61.20
HE1-20/PM20	HE2-20/PM20	1.1/4"	1.1/4"	POA	133.66
HE1-24/PM24	HE2-24/PM24	1.1/2"	1.1/2"	POA	133.78
HE1-32/PM32	HE2-32/PM32	2"	2"	POA	234.35

## HOSE END - STRAIGHT

### BSPT Male Straight, Suitable for 1 & 2 Wire

\*Two piece price includes Ferrule



Part Number		Hose	BSPT	List price (\$)	
One Piece	Two Piece	(A)	(B)	One Piece	Two Piece
HE1-04/TM02	HE2-04/TM02	1/4"	1/8"	15.17	14.04
HE1-04/TM04	HE2-04/TM04	1/4"	1/4"	13.61	12.52
HE1-06/TM04	HE2-06/TM04	3/8"	1/4"	18.07	19.87
HE1-04/TM06	HE2-04/TM06	1/4"	3/8"	18.00	16.26
HE1-06/TM06	HE2-06/TM06	3/8"	3/8"	15.49	13.81
HE1-08/TM06	HE2-08/TM06	1/2"	3/8"	16.85	22.82
HE1-04/TM08	HE2-04/TM08	1/4"	1/2"	13.66	15.06
HE1-06/TM08	HE2-06/TM08	3/8"	1/2"	18.99	15.63
HE1-08/TM08	HE2-08/TM08	1/2"	1/2"	18.19	15.60
HE1-10/TM08	HE2-10/TM08	5/8"	1/2"	26.56	34.31
HE1-12/TM08	HE2-12/TM08	3/4"	1/2"	45.50	43.5
HE1-08/TM10	HE2-08/TM10	1/2"	5/8"	POA	30.27
HE1-10/TM10	HE2-10/TM10	5/8"	5/8"	POA	47.17
HE1-06/TM12	HE2-06/TM12	3/8"	3/4"	POA	33.60
HE1-08/TM12	HE2-08/TM12	1/2"	3/4"	POA	43.61
HE1-10/TM12	HE2-10/TM12	5/8"	3/4"	POA	58.96
HE1-12/TM12	HE2-12/TM12	3/4"	3/4"	26.30	28.30
HE1-12/TM16	HE2-12/TM16	3/4"	1"	56.02	83.70
HE1-16/TM16	HE2-16/TM16	1"	1"	49.37	62.89
HE1-16/TM20	HE2-16/TM20	1"	1.1/4"	POA	262.66
HE1-20/TM20	HE2-20/TM20	1.1/4"	1.1/4"	POA	98.11
HE1-24/TM24	HE2-24/TM24	1.1/2"	1.1/2"	POA	124.49
HE1-32/TM32	HE2-32/TM32	2"	2"	POA	229.5

## HOSE END - 90° COMPACT

### BSPF Female Swivel 90° Compact Elbow, Suitable for 1 & 2 Wire

\*Two piece price includes Ferrule

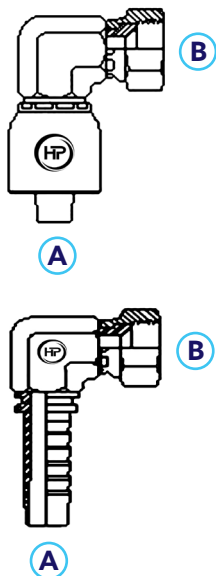

Part Number		Hose	BSPF	List price (\$)	
One Piece	Two Piece	(A)	(B)	One Piece	Two Piece
HE1-04/PFS04-9C	HE2-04/PFS04-9C	1/4"	1/4"	30.15	27.08
HE1-04/PFS06-9C	HE2-04/PFS06-9C	1/4"	3/8"	POA	23.19
HE1-06/PFS06-9C	HE2-06/PFS06-9C	3/8"	3/8"	32.69	32.41
HE1-06/PFS08-9C	HE2-06/PFS08-9C	3/8"	1/2"	POA	23.44
HE1-08/PFS08-9C	HE2-08/PFS08-9C	1/2"	1/2"	40.29	36.55
HE1-12/PFS12-9C	HE2-12/PFS12-9C	3/4"	3/4"	58.80	60.77
HE1-16/PFS16-9C	HE2-16/PFS16-9C	1"	1"	119.8	97.46

## HOSE END - 90° SWEPT

### BSPF Female Swivel 90° Swept Elbow, Suitable for 1 & 2 Wire

\*Two piece price includes Ferrule

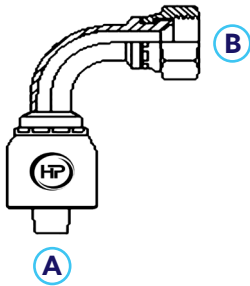

A

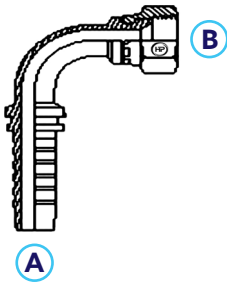

A

Part Number		Hose	BSPF	List price (\$)	
One Piece	Two Piece	A	B	One Piece	Two Piece
HE1-04/PFS04-9S	HE2-04/PFS04-9S	1/4"	1/4"	27.67	29.43
HE1-04/PFS06-9S	HE2-04/PFS06-9S	1/4"	3/8"	48.59	37.41
HE1-06/PFS06-9S	HE2-06/PFS06-9S	3/8"	3/8"	30.57	31.78
HE1-06/PFS08-9S	HE2-06/PFS08-9S	3/8"	1/2"	44.91	43.28
HE1-08/PFS08-9S	HE2-08/PFS08-9S	1/2"	1/2"	34.53	35.12
HE1-08/PFS10-9S	HE2-08/PFS10-9S	1/2"	5/8"	POA	46.43
HE1-10/PFS10-9S	HE2-10/PFS10-9S	5/8"	5/8"	POA	58.13
HE1-08/PFS12-9S	HE2-08/PFS12-9S	1/2"	3/4"	POA	57.48
HE1-10/PFS12-9S	HE2-10/PFS12-9S	5/8"	3/4"	POA	66.32
HE1-12/PFS12-9S	HE2-12/PFS12-9S	3/4"	3/4"	49.53	52.69
HE1-16/PFS16-9S	HE2-16/PFS16-9S	1"	1"	79.51	85.53
HE1-20/PFS20-9S	HE2-20/PFS20-9S	1.1/4"	1.1/4"	POA	162.43
HE1-24/PFS24-9S	HE2-24/PFS24-9S	1.1/2"	1.1/2"	POA	255.05
HE1-32/PFS32-9S	HE2-32/PFS32-9S	2"	2"	POA	431.87

## HOSE END - 45° SWEPT

### BSPF Female Swivel 45° Swept Elbow, Suitable for 1 & 2 Wire

\*Two piece price includes Ferrule

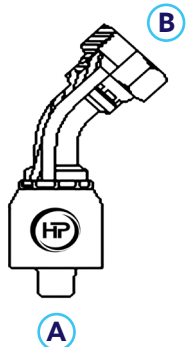

A

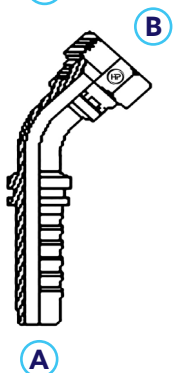

A

Part Number		Hose	BSPF	List price (\$)	
One Piece	Two Piece	A	B	One Piece	Two Piece
HE1-04/PFS04-4S	HE2-04/PFS04-4S	1/4"	1/4"	29.39	32.22
HE1-04/PFS06-4S	HE2-04/PFS06-4S	1/4"	3/8"	39.92	39.05
HE1-06/PFS06-4S	HE2-06/PFS06-4S	3/8"	3/8"	32.24	34.40
HE1-06/PFS08-4S	HE2-06/PFS08-4S	3/8"	1/2"	POA	47.08
HE1-08/PFS08-4S	HE2-08/PFS08-4S	1/2"	1/2"	35.76	37.28
HE1-10/PFS10-4S	HE2-10/PFS10-4S	5/8"	5/8"	POA	74.52
HE1-12/PFS12-4S	HE2-12/PFS12-4S	3/4"	3/4"	51.01	55.14
HE1-16/PFS16-4S	HE2-16/PFS16-4S	1"	1"	79.83	84.81
HE1-20/PFS20-4S	HE2-20/PFS20-4S	1.1/4"	1.1/4"	POA	186.90
HE1-24/PFS24-4S	HE2-24/PFS24-4S	1.1/2"	1.1/2"	POA	318.51
HE1-32/PFS32-4S	HE2-32/PFS32-4S	2"	2"	POA	621.76



# ADAPTORS

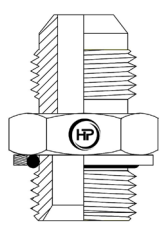
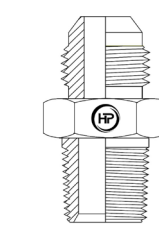
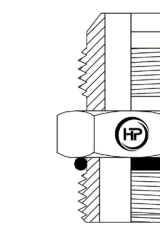
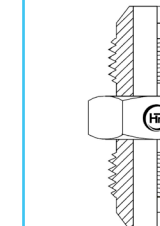
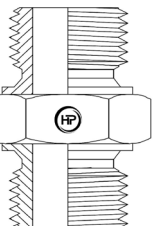
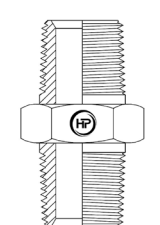
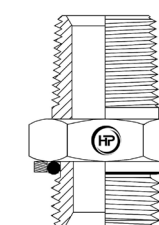
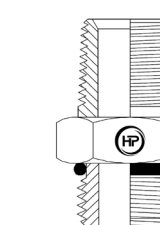
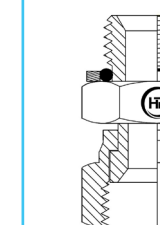
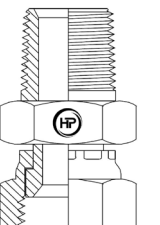
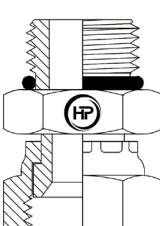
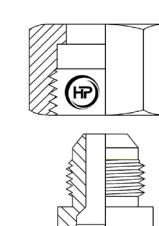
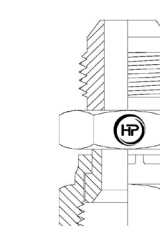
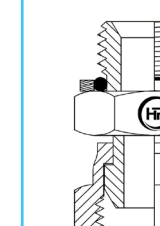
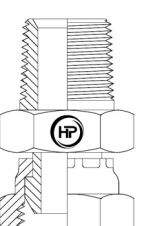
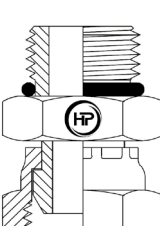
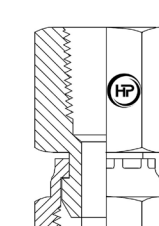
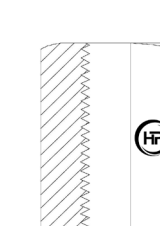
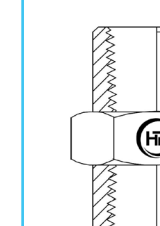
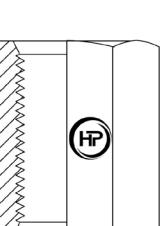

<p><b>JICM X BSPPM STRAIGHT (M X M)</b></p>  <p>Page 26</p>	<p><b>JICM X BSPTM STRAIGHT (M X M)</b></p>  <p>Page 27</p>	<p><b>JICM X UNOM STRAIGHT (M X M)</b></p>  <p>Page 28</p>	<p><b>JICM X JICM STRAIGHT (M X M)</b></p>  <p>Page 29</p>	<p><b>BSPPM X BSPPM STRAIGHT (M X M)</b></p>  <p>Page 29</p>
<p><b>BSPTM X BSPTM STRAIGHT (M X M)</b></p>  <p>Page 30</p>	<p><b>BSPTM X BSPPM STRAIGHT (M X M)</b></p>  <p>Page 30</p>	<p><b>BSPTM X UNOM STRAIGHT (M X M)</b></p>  <p>Page 31</p>	<p><b>BSPPM X JICF STRAIGHT (M X FS)</b></p>  <p>Page 32</p>	<p><b>BSPTM X JICF STRAIGHT (M X FS)</b></p>  <p>Page 32</p>
<p><b>UNOM X JICF STRAIGHT (M X FS)</b></p>  <p>Page 33</p>	<p><b>JICM X JICF (TR) STRAIGHT (M X FS)</b></p>  <p>Page 33</p>	<p><b>JICM X JICF STRAIGHT (M X FS)</b></p>  <p>Page 34</p>	<p><b>BSPPM X BSPPF STRAIGHT (M X FS)</b></p>  <p>Page 34</p>	<p><b>BSPTM X BSPPF STRAIGHT (M X FS)</b></p>  <p>Page 34</p>
<p><b>UNOM X BSPPF STRAIGHT (M X FS)</b></p>  <p>Page 35</p>	<p><b>BSPTF X BSPPF STRAIGHT (F X FS)</b></p>  <p>Page 35</p>	<p><b>BSPPF X BSPPF STRAIGHT FIXED (F X F)</b></p>  <p>Page 36</p>	<p><b>BSPTF X BSPTF STRAIGHT FIXED (F X F)</b></p>  <p>Page 36</p>	<p><b>UNOF X UNOF STRAIGHT FIXED (F X F)</b></p>  <p>Page 36</p>

*For other sizes and thread types please contact us*

# ADAPTOR - STRAIGHT (M X M)

## JIC Male x BSPP Male - Straight

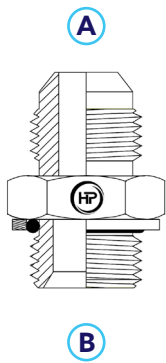

Part Number	A JIC (M)	B BSPP (M)	List Price (\$)
BPM-JIM-0207	7/16"	1/8"	10.10
BPM-JIM-0407	7/16"	1/4"	7.15
BPM-JIM-0607	7/16"	3/8"	10.64
BPM-JIM-0807	7/16"	1/2"	15.87
BPM-JIM-0408	1/2"	1/4"	11.20
BPM-JIM-0209	9/16"	1/8"	11.74
BPM-JIM-0409	9/16"	1/4"	8.79
BPM-JIM-0609	9/16"	3/8"	7.69
BPM-JIM-0809	9/16"	1/2"	10.79
BPM-JIM-1209	9/16"	3/4"	20.31
BPM-JIM-0412	3/4"	1/4"	10.66
BPM-JIM-0612	3/4"	3/8"	8.20
BPM-JIM-0612E70	3/4"	3/8"	18.96
BPM-JIM-0612E95	3/4"	3/8"	24.86
BPM-JIM-0812	3/4"	1/2"	9.15
BPM-JIM-1212	3/4"	3/4"	15.48
BPM-JIM-1612	3/4"	1"	27.09
BPM-JIM-0614	7/8"	3/8"	13.37
BPM-JIM-0814	7/8"	1/2"	9.61
BPM-JIM-1214	7/8"	3/4"	16.55
BPM-JIM-1614	7/8"	1"	34.71
BPM-JIM-0417	1.1/16"	1/4"	34.59
BPM-JIM-0617	1.1/16"	3/8"	21.62
BPM-JIM-0817	1.1/16"	1/2"	15.03
BPM-JIM-1217	1.1/16"	3/4"	15.66
BPM-JIM-1617	1.1/16"	1"	25.73
BPM-JIM-2017	1.1/16"	1.1/4"	48.98
BPM-JIM-2417	1.1/16"	1.1/2"	169.41
BPM-JIM-2112	1.5/16"	3/4"	30.24
BPM-JIM-1621	1.5/16"	1"	24.71
BPM-JIM-2021	1.5/16"	1.1/4"	46.30
BPM-JIM-2421	1.5/16"	1.1/2"	93.38
BPM-JIM-3221	1.5/16"	2"	200.17
BPM-JIM-1226	1.5/8"	3/4"	127.74
BPM-JIM-1626	1.5/8"	1"	35.40
BPM-JIM-2026	1.5/8"	1.1/4"	47.00
BPM-JIM-2426	1.5/8"	1.1/2"	106.68
BPM-JIM-1630	1.7/8"	1"	118.21
BPM-JIM-2030	1.7/8"	1.1/4"	104.07
BPM-JIM-2430	1.7/8"	1.1/2"	88.27
BPM-JIM-3230	1.7/8"	2"	149.19
BPM-JIM-3240	2.1/2"	2"	152.99

# ADAPTOR - STRAIGHT (M X M)

## JIC Male x BSPT Male - Straight

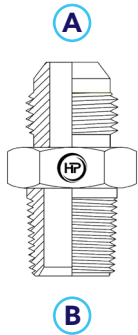

Part Number	<b>A</b> JIC (M)	<b>B</b> BSPT (M)	List Price (\$)
BTM-JIM-0207	7/16"	1/8"	3.73
BTM-JIM-0407	7/16"	1/4"	4.10
BTM-JIM-0607	7/16"	3/8"	7.99
BTM-JIM-0807	7/16"	1/2"	12.71
BTM-JIM-0208	1/2"	1/8"	POA
BTM-JIM-0408	1/2"	1/4"	4.89
BTM-JIM-0608	1/2"	3/8"	12.42
BTM-JIM-0209	9/16"	1/8"	4.82
BTM-JIM-0409	9/16"	1/4"	4.02
BTM-JIM-0609	9/16"	3/8"	4.73
BTM-JIM-0809	9/16"	1/2"	7.60
BTM-JIM-1209	9/16"	3/4"	14.00
BTM-JIM-0412	3/4"	1/4"	8.70
BTM-JIM-0612	3/4"	3/8"	5.03
BTM-JIM-0812	3/4"	1/2"	6.37
BTM-JIM-1212	3/4"	3/4"	10.94
BTM-JIM-1612	3/4"	1"	22.71
BTM-JIM-0614	7/8"	3/8"	7.75
BTM-JIM-0814	7/8"	1/2"	7.01
BTM-JIM-1214	7/8"	3/4"	9.39
BTM-JIM-1614	7/8"	1.1/4"	24.14
BTM-JIM-1617	1.1/16"	3/8"	15.58
BTM-JIM-0817	1.1/16"	1/2"	12.24
BTM-JIM-1217	1.1/16"	3/4"	8.62
BTM-JIM-1617	1.1/16"	1"	15.58
BTM-JIM-2017	1.1/16"	1.1/4"	40.04
BTM-JIM-0821	1.5/16"	1/2"	15.87
BTM-JIM-1221	1.5/16"	3/4"	15.80
BTM-JIM-1621	1.5/16"	1"	14.95
BTM-JIM-2021	1.5/16"	1.1/4"	30.72
BTM-JIM-2421	1.5/16"	1.1/2"	61.99
BTM-JIM-1626	1.5/8"	1"	35.25
BTM-JIM-2026	1.5/8"	1.1/4"	32.17
BTM-JIM-2426	1.5/8"	1.1/2"	61.06
BTM-JIM-3226	1.5/8"	2"	100.98
BTM-JIM-2030	1.7/8"	1.1/4"	62.04
BTM-JIM-2430	1.7/8"	1.1/2"	53.01
BTM-JIM-3230	1.7/8"	2"	118.90
BTM-JIM-2440	2.1/2"	1.1/2"	80.92
BTM-JIM-3240	2.1/2"	2"	117.32

# ADAPTOR - STRAIGHT (M X M)

## JIC Male x UNO Male - Straight

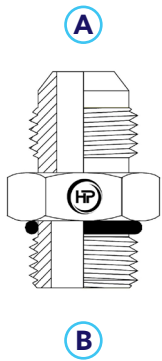

Part Number	A JIC (M)	B UNO (M)	List Price (\$)
JIM-UNM-0707	7/16"	7/16"	6.36
JIM-UNM-0708	7/16"	1/2"	7.31
JIM-UNM-0709	7/16"	9/16"	8.02
JIM-UNM-0712	7/16"	3/4"	10.64
JIM-UNM-0808	1/2"	1/2"	9.83
JIM-UNM-0809	1/2"	9/16"	11.20
JIM-UNM-0812	1/2"	3/4"	57.86
JIM-UNM-0907	9/16"	7/16"	7.91
JIM-UNM-0908	9/16"	1/2"	12.42
JIM-UNM-0909	9/16"	9/16"	5.21
JIM-UNM-0912	9/16"	3/4"	6.29
JIM-UNM-0914	9/16"	7/8"	7.98
JIM-UNM-0917	9/16"	1.1/16"	18.98
JIM-UNM-1207	3/4"	7/16"	18.32
JIM-UNM-1209	3/4"	9/16"	6.66
JIM-UNM-1212	3/4"	3/4"	5.58
JIM-UNM-1214	3/4"	7/8"	7.79
JIM-UNM-1217	3/4"	1.1/16"	13.19
JIM-UNM-1221	3/4"	1.5/16"	34.54
JIM-UNM-1409	7/8"	9/16"	17.37
JIM-UNM-1412	7/8"	3/4"	9.88
JIM-UNM-1414	7/8"	7/8"	7.50
JIM-UNM-1417	7/8"	1.1/16"	13.21
JIM-UNM-1421	7/8"	1.5/16"	23.67
JIM-UNM-1712	1.1/16"	3/4"	15.51
JIM-UNM-1714	1.1/16"	7/8"	14.02
JIM-UNM-1717	1.1/16"	1.1/16"	11.71
JIM-UNM-1719	1.1/16"	1.3/16"	33.03
JIM-UNM-1721	1.1/16"	1.5/16"	18.12
JIM-UNM-1726	1.1/16"	1.5/8"	49.74
JIM-UNM-2114	1.5/16"	7/8"	29.76
JIM-UNM-2117	1.5/16"	1.1/16"	18.84
JIM-UNM-2119	1.5/16"	1.3/16"	38.44
JIM-UNM-2121	1.5/16"	1.5/16"	16.70
JIM-UNM-2126	1.5/16"	1.5/8"	33.92
JIM-UNM-2130	1.5/16"	1.7/8"	82.65
JIM-UNM-2617	1.5/8"	1.1/16"	60.11
JIM-UNM-2621	1.5/8"	1.5/16"	37.07
JIM-UNM-2626	1.5/8"	1.5/8"	34.78
JIM-UNM-2630	1.5/8"	1.7/8"	69.95
JIM-UNM-3030	1.7/8"	1.7/8"	63.30
JIM-UNM-4040	2.1/2"	2.1/2"	95.63

## ADAPTOR - STRAIGHT (M X M)

### JIC Male x JIC Male - Straight

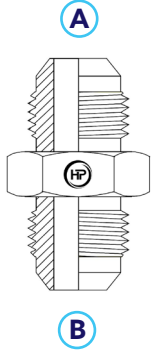

Part Number	A JIC (M)	B JIC (M)	List Price (\$)
JIM-JIM-0707	7/16"	7/16"	3.94
JIM-JIM-0808	1/2"	1/2"	5.12
JIM-JIM-0709	9/16"	7/16"	7.69
JIM-JIM-0909	9/16"	9/16"	4.10
JIM-JIM-0712	3/4"	7/16"	8.58
JIM-JIM-0912	3/4"	9/16"	12.14
JIM-JIM-1212	3/4"	3/4"	5.89
JIM-JIM-0914	7/8"	9/16"	11.83
JIM-JIM-1214	7/8"	3/4"	9.59
JIM-JIM-1414	7/8"	7/8"	7.84
JIM-JIM-1217	1.1/16"	3/4"	19.22
JIM-JIM-1417	1.1/16"	7/8"	15.30
JIM-JIM-1717	1.1/16"	1.1/16"	11.76
JIM-JIM-1919	1.3/16"	1.3/16"	28.73
JIM-JIM-1421	1.5/16"	7/8"	19.46
JIM-JIM-1721	1.5/16"	1.1/16"	19.01
JIM-JIM-2121	1.5/16"	1.5/16"	16.25
JIM-JIM-2126	1.5/8"	1.5/16"	39.41
JIM-JIM-2626	1.5/8"	1.5/8"	36.12
JIM-JIM-3030	1.7/8"	1.7/8"	101.36
JIM-JIM-4040	2.1/2"	2.1/2"	189.91

## ADAPTOR - STRAIGHT (M X M)

### BSPM Male x BSPM Male - Straight

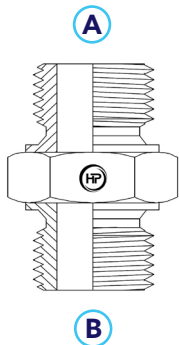

Part Number	A BSPM (M)	B BSPM (M)	List Price (\$)
BPM-BPM-0404	1/4"	1/4"	8.27
BPM-BPM-0406	3/8"	1/4"	8.91
BPM-BPM-0606	3/8"	3/8"	8.58
BPM-BPM-0408	1/2"	1/4"	11.23
BPM-BPM-0608	1/2"	3/8"	8.69
BPM-BPM-0808	1/2"	1/2"	10.04
BPM-BPM-0812	3/4"	1/2"	13.96
BPM-BPM-1212	3/4"	3/4"	14.08
BPM-BPM-0816	1"	1/2"	24.42
BPM-BPM-1216	1"	3/4"	23.47
BPM-BPM-1616	1"	1"	23.47
BPM-BPM-2020	1.1/4"	1.1/4"	48.68

## ADAPTOR - STRAIGHT (M X M)

### BSPT Male x BSPT Male - Straight

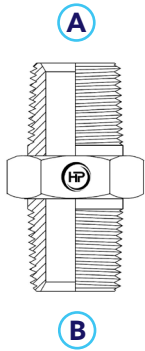

Part Number	A BSPT (M)	B BSPT (M)	List Price (\$)
BTM-BTM-0202	1/8"	1/8"	8.02
BTM-BTM-0204	1/4"	1/8"	8.50
BTM-BTM-0404	1/4"	1/4"	6.15
BTM-BTM-0206	3/8"	1/8"	POA
BTM-BTM-0406	3/8"	1/4"	9.00
BTM-BTM-0606	3/8"	3/8"	7.79
BTM-BTM-0408	1/2"	1/4"	12.44
BTM-BTM-0608	1/2"	3/8"	10.13
BTM-BTM-0808	1/2"	1/2"	9.74
BTM-BTM-0412	3/4"	1/2"	POA
BTM-BTM-0612	3/4"	3/4"	15.56
BTM-BTM-0812	1"	3/8"	14.37
BTM-BTM-1212	1"	3/4"	13.15
BTM-BTM-0616	1"	1"	POA
BTM-BTM-0816	1.1/4"	3/4"	28.75
BTM-BTM-1216	1.1/4"	1"	24.73
BTM-BTM-1616	1.1/4"	1.1/4"	24.15
BTM-BTM-1220	1.1/2"	3/4"	67.24
BTM-BTM-1620	1.1/2"	1"	44.70
BTM-BTM-2020	1.1/2"	1.1/4"	44.34
BTM-BTM-1224	1.1/2"	1.1/2"	POA
BTM-BTM-1624	1.1/2"	1"	POA
BTM-BTM-2024	1.1/2"	1.1/4"	81.35
BTM-BTM-2424	1.1/2"	1.1/2"	77.38
BTM-BTM-2032	2	1.1/4	POA
BTM-BTM-2432	2	1.1/2	POA
BTM-BTM-3232	2	2	162.90

## ADAPTOR - STRAIGHT (M X M)

Continued...

### BSPT Male x BSPP Male - Straight

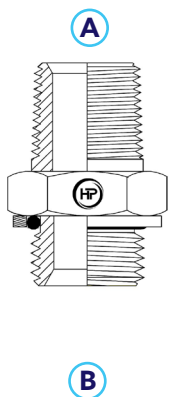

Part Number	A BSPT (M)	B BSPP (M)	List Price (\$)
BPM-BTM-0202	1/8"	1/8"	8.02
BPM-BTM-0204	1/8"	1/4"	8.50
BPM-BTM-0402	1/4"	1/8"	8.35
BPM-BTM-0404	1/4"	1/4"	6.15
BPM-BTM-0406	1/4"	3/8"	9.00
BPM-BTM-0408	1/4"	1/2"	12.44
BPM-BTM-0604	3/8"	1/4"	7.51
BPM-BTM-0606	3/8"	3/8"	7.79
BPM-BTM-0608	3/8"	1/2"	10.13
BPM-BTM-0612	3/8"	3/4"	15.56

Continued on the following page...



## ADAPTOR - STRAIGHT (M X M)

...Continued

### BSPT Male x BSPP Male - Straight

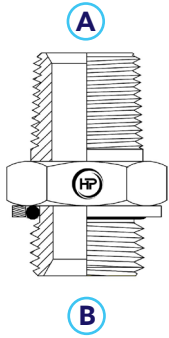

BPM-BTM-0804	1/2"	1/4"	12.59
BPM-BTM-0806	1/2"	3/8"	10.18
BPM-BTM-0808	1/2"	1/2"	9.74
BPM-BTM-0812	1/2"	3/4"	14.37
BPM-BTM-0816	1/2"	1"	28.75
BPM-BTM-1206	3/4"	3/8"	15.83
BPM-BTM-1208	3/4"	1/2"	13.58
BPM-BTM-1212	3/4"	3/4"	13.15
BPM-BTM-1216	3/4"	1"	24.73
BPM-BTM-1608	1"	1/2"	25.49
BPM-BTM-1612	1"	3/4"	26.95
BPM-BTM-1616	1"	1"	24.15
BPM-BTM-1620	1"	1.1/4"	44.70
BPM-BTM-1220	1.1/4"	3/4"	67.24
BPM-BTM-2016	1.1/4"	1"	53.10
BPM-BTM-2020	1.1/4"	1.1/4"	44.34
BPM-BTM-2024	1.1/4"	1.1/2"	81.35
BPM-BTM-2420	1.1/2"	1.1/4"	86.75
BPM-BTM-2424	1.1/2"	1.1/2"	78.38
BPM-BTM-3232	2"	2"	162.90

## ADAPTOR - STRAIGHT (M X M)

### BSPT Male x UNO Male - Straight

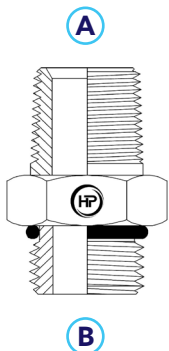

Part Number	A BSPT (M)	B UNO (M)	List Price (\$)
BTM-UNM-0407	1/4"	7/16"	8.26
BTM-UNM-0409	1/4"	9/16"	8.05
BTM-UNM-0412	1/4"	3/4"	9.47
BTM-UNM-0414	1/4"	7/8"	19.60
BTM-UNM-0609	3/8"	9/16"	8.32
BTM-UNM-0612	3/8"	3/4"	8.67
BTM-UNM-0614	3/8"	7/8"	9.74
BTM-UNM-0809	1/2"	9/16"	10.59
BTM-UNM-0812	1/2"	3/4"	8.23
BTM-UNM-0814	1/2"	7/8"	10.31
BTM-UNM-0817	1/2"	1.1/16"	15.27
BTM-UNM-1212	1/2"	1.5/16"	18.84
BTM-UNM-1214	3/4"	3/4"	16.73
BTM-UNM-1217	3/4"	7/8"	16.34
BTM-UNM-1221	3/4"	1.1/16"	21.29
BTM-UNM-1617	3/4"	1.5/16"	18.98
BTM-UNM-1621	1"	1.1/16"	21.52
BTM-UNM-1626	1"	1.5/16"	52.48

## ADAPTOR - STRAIGHT (M X F)

### BSPP Male x JIC Female Swivel - Straight

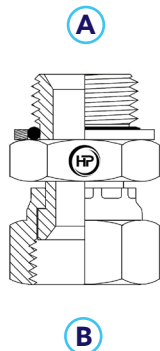

Part Number	A BSPP (M)	B JIC (FS)	List Price (\$)
BPM-JIF-0207	1/8"	7/16"	15.39
BPM-JIF-0407	1/4"	7/16"	15.58
BPM-JIF-0409	1/4"	9/16"	15.21
BPM-JIF-0412	1/4"	3/4"	18.89
BPM-JIF-0609	3/8"	9/16"	17.91
BPM-JIF-0612	3/8"	3/4"	18.36
BPM-JIF-0614	3/8"	7/8"	25.14
BPM-JIF-0809	1/2"	9/16"	21.24
BPM-JIF-0812	1/2"	3/4"	19.94
BPM-JIF-0814	1/2"	7/8"	23.43
BPM-JIF-0817	1/2"	1.1/16"	36.21
BPM-JIF-1214	3/4"	7/8"	33.42
BPM-JIF-1217	3/4"	1.1/16"	31.48
BPM-JIF-1617	1"	1.1/16"	49.94
BPM-JIF-1621	1"	1.5/16"	46.42
BPM-JIF-2026	1.1/4"	1.5/8"	77.34
BPM-JIF-2430	1.1/2"	1.7/8"	107.46

## ADAPTOR - STRAIGHT (M X F)

### BSPT Male x JIC Female Swivel - Straight

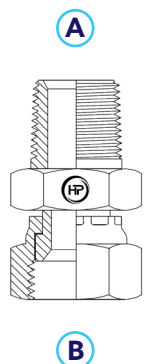

Part Number	A BSPT (M)	B JIC (FS)	List Price (\$)
BTM-JIF-0207	1/8"	7/16"	16.97
BTM-JIF-0407	1/4"	7/16"	16.18
BTM-JIF-0409	1/4"	9/16"	11.31
BTM-JIF-0414	1/4"	7/8"	20.74
BTM-JIF-0609	3/8"	9/16"	17.49
BTM-JIF-0612	3/8"	3/4"	19.33
BTM-JIF-0614	3/8"	7/8"	21.17
BTM-JIF-0809	1/2"	9/16"	19.13
BTM-JIF-0812	1/2"	3/4"	20.08
BTM-JIF-0814	1/2"	7/8"	19.62
BTM-JIF-0817	1/2"	1.1/16"	30.83
BTM-JIF-1217	3/4"	1.1/16"	29.25
BTM-JIF-1617	1"	1.1/16"	37.42
BTM-JIF-1621	1"	1.5/16"	34.31
BTM-JIF-2026	1.1/4"	1.5/8"	78.25
BTM-JIF-2426	1.1/2"	1.5/8"	178.47
BTM-JIF-2430	1.1/2"	1.7/8"	143.01

## ADAPTOR - STRAIGHT (M X F)

### UNO Male x JIC Female Swivel - Straight

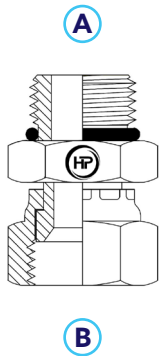

Part Number	A UNO (M)	B JIC (FS)	List Price (\$)
JIF-UNM-0707	7/16"	7/16"	10.59
JIF-UNM-0907	7/16"	9/16"	16.04
JIF-UNM-0709	9/16"	7/16"	16.10
JIF-UNM-0909	9/16"	9/16"	12.10
JIF-UNM-1209	9/16"	3/4"	16.53
JIF-UNM-0912	3/4"	9/16"	16.93
JIF-UNM-1212	3/4"	3/4"	13.58
JIF-UNM-1412	3/4"	7/8"	28.24
JIF-UNM-1712	3/4"	1.1/16"	35.59
JIF-UNM-0914	7/8"	9/16"	29.11
JIF-UNM-1214	7/8"	3/4"	18.18
JIF-UNM-1414	7/8"	7/8"	19.79
JIF-UNM-1714	7/8"	1.1/16"	35.64
JIF-UNM-1217	1.1/16"	3/4"	36.83
JIF-UNM-1417	1.1/16"	7/8"	36.23
JIF-UNM-1717	1.1/16"	1.1/16"	24.89
JIF-UNM-2117	1.1/16"	1.5/16"	59.40
JIF-UNM-1721	1.5/16"	1.1/16"	53.46
JIF-UNM-2121	1.5/16"	1.5/16"	38.05
JIF-UNM-2626	1.5/8"	1.5/8"	73.42
JIF-UNM-3030	1.7/8"	1.7/8"	78.41

## ADAPTOR - STRAIGHT (M X F)

### JIC Male x JIC Female (Expander) - Straight

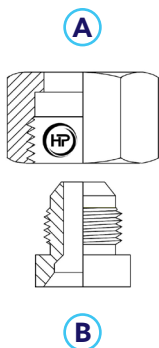

Part Number	A JIC (F)	B JIC (M)	List Price (\$)
JIM-JFF-0706	3/8"	7/16"	14.63
JIM-JFF-0907	7/16"	9/16"	20.62
JIM-JFF-1207	7/16"	3/4"	22.52
JIM-JFF-0809	9/16"	1/2"	20.91
JIM-JFF-1209	9/16"	3/4"	19.55
JIM-JFF-1412	3/4"	7/8"	15.09
JIM-JFF-1712	3/4"	1.1/16"	22.93
JIM-JFF-2112	3/4"	1.5/16"	32.43
JIM-JFF-1214	7/8"	3/4"	21.15
JIM-JFF-1714	7/8"	1.1/16"	25.28
JIM-JFF-1417	1.1/16"	7/8"	22.87
JIM-JFF-2117	1.1/16"	1.5/16"	27.03
JIM-JFF-2621	1.5/16"	1.5/8"	71.25
JIM-JFF-3021	1.5/16"	1.7/8"	73.66
JIM-JFF-3026	1.5/8"	1.7/8"	113.71
JIM-JFF-4030	1.7/8"	2.1/2"	190.46

## ADAPTOR - STRAIGHT (M X F)

### JIC Male x JIC Female Swivel - Straight

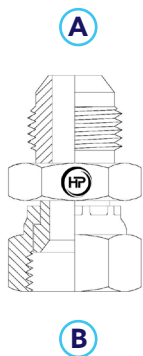

Part Number	A JIC (M)	B JIC (FS)	List Price (\$)
JIM-JIF-0707	7/16"	7/16"	13.96
JIM-JIF-0909	9/16"	9/16"	11.91
JIM-JIF-1212	3/4"	3/4"	15.41
JIM-JIF-1414	7/8"	7/8"	18.44
JIM-JIF-1717	1.1/16"	1.1/16"	25.92
JIM-JIF-2121	1.5/16"	1.5/16"	54.65
JIM-JIF-2626	1.5/8"	1.5/8"	57.56
JIM-JIF-3030	1.7/8"	1.7/8"	114.35

## ADAPTOR - STRAIGHT (M X F)

### BSPP Male x BSPP Female Swivel - Straight

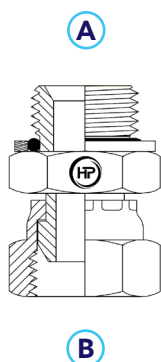

Part Number	A BSPP (M)	B BSPP (FS)	List Price (\$)
BPM-BSF-0202	1/8"	1/8"	14.20
BPM-BSF-0404	1/4"	1/4"	14.32
BPM-BSF-0406	1/4"	3/8"	17.82
BPM-BSF-0606	3/8"	3/8"	14.04
BPM-BSF-0608	3/8"	1/2"	19.52
BPM-BSF-0806	1/2"	3/8"	19.27
BPM-BSF-0808	1/2"	1/2"	18.39
BPM-BSF-0812	1/2"	3/4"	35.35
BPM-BSF-1212	3/4"	3/4"	26.00
BPM-BSF-1216	3/4"	1"	61.60
BPM-BSF-1612	1"	3/4"	54.00
BPM-BSF-1616	1"	1"	45.14
BPM-BSF-1620	1"	1.1/4"	109.3
BPM-BSF-2020	1.1/4"	1.1/4"	70.12

## ADAPTOR - STRAIGHT (M X F)

Continued...

### BSPT Male x BSPP Female Swivel - Straight

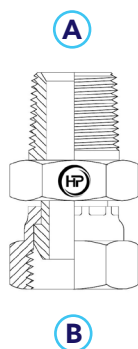

Part Number	A BSPT (M)	B BSPP (FS)	List Price (\$)
BTM-BSF-0202	1/8"	1/8"	10.84
BTM-BSF-0204	1/8"	1/4"	10.88
BTM-BSF-0402	1/4"	1/8"	10.94
BTM-BSF-0404	1/4"	1/4"	8.43
BTM-BSF-0406	1/4"	3/8"	9.98
BTM-BSF-0408	1/4"	1/2"	14.80
BTM-BSF-0604	3/8"	1/4"	15.98
BTM-BSF-0606	3/8"	3/8"	POA

Continued on the following page...

## ADAPTOR - STRAIGHT (M X F)

...Continued

### BSPT Male x BSPP Female Swivel - Straight

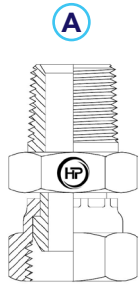

BTM-BSF-0608	3/8"	1/2"	16.24
BTM-BSF-0806	1/2"	3/8"	15.37
BTM-BSF-0808	1/2"	1/2"	14.12
BTM-BSF-0812	1/2"	3/4"	24.85
BTM-BSF-1208	3/4"	1/2"	22.72
BTM-BSF-1212	3/4"	3/4"	22.24
BTM-BSF-1216	3/4"	1"	34.57
BTM-BSF-1612	1"	3/4"	41.22
BTM-BSF-1616	1"	1"	31.99
BTM-BSF-1620	1"	1.1/4"	75.83
BTM-BSF-2016	1.1/4"	1"	118.68
BTM-BSF-2020	1.1/4"	1.1/4"	67.33
BTM-BSF-2424	1.1/2"	1.1/2"	117.88

## ADAPTOR - STRAIGHT (M X F)

### UNO Male x BSPP Female Swivel - Straight

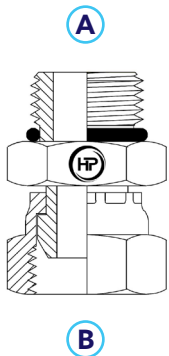

Part Number	A UNO (M)	B BSPP (FS)	List Price (\$)
BSF-UNM-0409	9/16"	1/4"	12.24
BSF-UNM-0609	9/16"	3/8"	12.78
BSF-UNM-0809	9/16"	1/2"	23.17
BSF-UNM-0612	3/4"	3/8"	14.73
BSF-UNM-0812	3/4"	1/2"	14.49
BSF-UNM-0614	7/8"	3/8"	23.11
BSF-UNM-0814	7/8"	1/2"	21.92
BSF-UNM-1214	7/8"	3/4"	34.88
BSF-UNM-1217	1.1/16"	3/4"	26.82
BSF-UNM-1621	1.5/16"	1"	39.64

## ADAPTOR - STRAIGHT (F X F)

### BSPT Female Fixed x BSPP Female Swivel - Straight

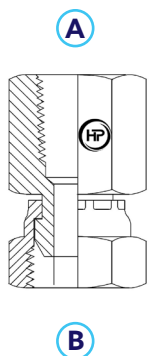

Part Number	A BSPT (F)	B BSPP (FS)	List Price (\$)
BTF-BSF-0404	1/4"	1/4"	17.32
BTF-BSF-0606	3/8"	3/8"	17.02
BTF-BSF-0806	1/2"	3/8"	23.64
BTF-BSF-0808	1/2"	1/2"	20.79
BTF-BSF-1212	3/4"	3/4"	37.51
BTF-BSF-1616	1"	1"	78.17

## ADAPTOR - STRAIGHT (F X F)

### BSPP Female x BSPP Female (Socket) - Straight Fixed

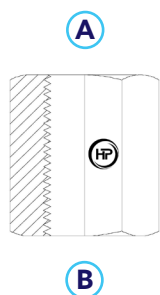

Part Number	(A) BSPP (F)	(B) BSPP (F)	List Price (\$)
BPF-BPF-0404	1/4"	1/4"	8.91
BPF-BPF-0606	3/8"	3/8"	9.54
BPF-BPF-0808	1/2"	1/2"	14.12
BPF-BPF-1212	3/4"	3/4"	16.22
BPF-BPF-1616	1"	1"	30.53

## ADAPTOR - STRAIGHT (F X F)

### BSPT Female x BSPT Female (Socket) - Straight Fixed

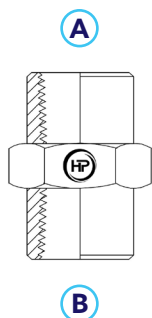

Part Number	(A) BSPT (F)	(B) BSPT (F)	List Price (\$)
BTF-BTF-0202	1/8"	1/8"	7.99
BTF-BTF-0204	1/4"	1/8"	9.39
BTF-BTF-0404	1/4"	1/4"	7.86
BTF-BTF-0604	3/8"	1/4"	10.08
BTF-BTF-0606	3/8"	3/8"	8.14
BTF-BTF-0408	1/2"	1/4"	18.26
BTF-BTF-0608	1/2"	3/8"	13.13
BTF-BTF-0808	1/2"	1/2"	9.39
BTF-BTF-0812	3/4"	1/2"	17.65
BTF-BTF-1212	3/4"	3/4"	15.29
BTF-BTF-1216	1"	3/4"	25.61
BTF-BTF-1616	1"	1"	22.93
BTF-BTF-1620	1.1/4"	1"	34.45
BTF-BTF-2020	1.1/4"	1.1/4"	34.60
BTF-BTF-2424	1.1/2"	1.1/2"	63.45
BTF-BTF-3232	2"	2"	96.55

## ADAPTOR - STRAIGHT (F X F)

### UNO Female x UNO Female (Socket) - Straight Fixed

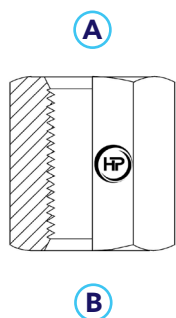

Part Number	(A) UNO (F)	(B) UNO (F)	List Price (\$)
UNF-UNF-0707	7/16"	7/16"	12.12
UNF-UNF-0909	9/16"	9/16"	27
UNF-UNF-1212	3/4"	3/4"	17.05
UNF-UNF-1414	7/8"	7/8"	22.22
UNF-UNF-1717	1.1/16"	1.1/16"	29.05
UNF-UNF-2121	1.5/16"	1.5/16"	32.43
UNF-UNF-2626	1.5/8"	1.5/8"	71.28

JICM X BSPPM  
90° ELBOW (M X M)

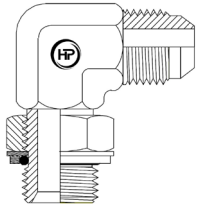

Page 38

JICM X BSPTM  
90° ELBOW (M X M)

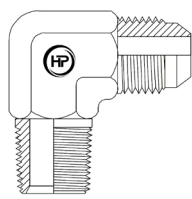

Page 38

JICM X UNOM  
90° ELBOW (M X M)

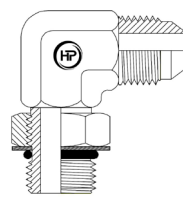

Page 39

JICM X UNOM  
EXT. 90° ELBOW (M X M)

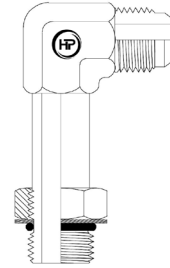

Page 40

JICM X JICM  
90° ELBOW (M X M)

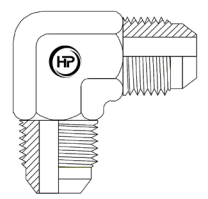

Page 40

BSPPM X BSPPM  
90° ELBOW (M X M)

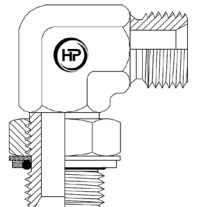

Page 41

BSPTM X BSPTM  
90° ELBOW (M X M)

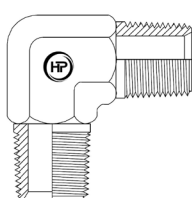

Page 41

BSPTM X BSPPM  
90° ELBOW (M X M)

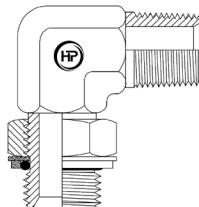

Page 41

BSPTM X UNOM  
90° ELBOW (M X M)

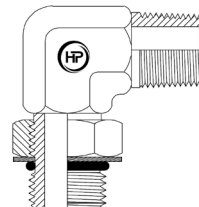

Page 42

UNOM X JICF  
90° ELBOW (M X FS)

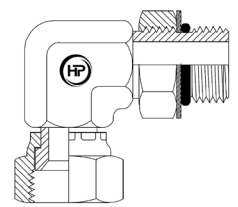

Page 42

JICM X JICF  
90° ELBOW (M X FS)

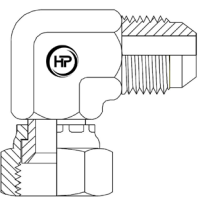

Page 43

JICM X JICF  
90° BEND (M X FS)

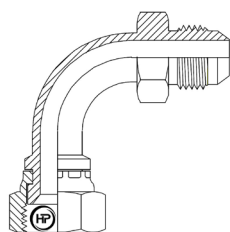

Page 43

JICM X JICF  
90° LONG BEND (M X FS)

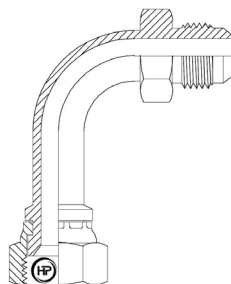

Page 43

BSPPM X BSPPF  
90° ELBOW (M X FS)

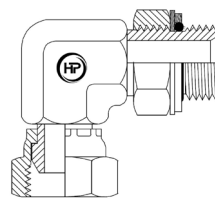

Page 44

BSPTM X BSPPF  
90° ELBOW (M X FS)

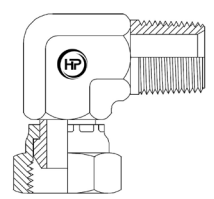

Page 44

UNOM X BSPPF  
90° ELBOW (M X FS)

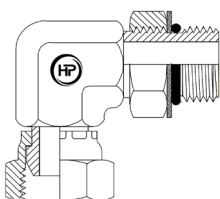

Page 44

BSPTM X BSPTF  
90° FIXED ELBOW (M X F)

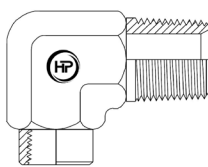

Page 45

BSPTF X BSPTF  
90° FIXED ELBOW (F X F)

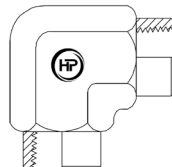

Page 45

For other sizes and thread types please contact us

## ADAPTOR - 90° ELBOW (M X M)

### JIC Male x BSPP Male - 90° Elbow

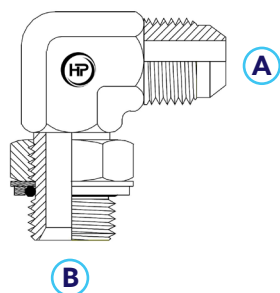

Part Number	A JIC (M)	B BSPP (M)	List Price (\$)
BPM-JIM-90C-0207	7/16"	1/8"	23.00
BPM-JIM-90C-0407	7/16"	1/4"	21.23
BPM-JIM-90C-0607	7/16"	3/8"	23.14
BPM-JIM-90C-0408	1/2"	1/4"	28.46
BPM-JIM-90C-0209	9/16"	1/8"	26.08
BPM-JIM-90C-0409	9/16"	1/4"	22.30
BPM-JIM-90C-0609	9/16"	3/8"	22.81
BPM-JIM-90C-0809	9/16"	1/2"	29.29
BPM-JIM-90C-1209	9/16"	3/4"	47.47
BPM-JIM-90C-0412	3/4"	1/4"	24.95
BPM-JIM-90C-0612	3/4"	3/8"	23.47
BPM-JIM-90C-0812	3/4"	1/2"	27.82
BPM-JIM-90C-1212	3/4"	3/4"	41.48
BPM-JIM-90C-0614	7/8"	3/8"	29.76
BPM-JIM-90C-0814	7/8"	1/2"	29.82
BPM-JIM-90C-1214	7/8"	3/4"	38.58
BPM-JIM-90C-0817	1.1/16"	1/2"	36.39
BPM-JIM-90C-1217	1.1/16"	3/4"	42.08
BPM-JIM-90C-1617	1.1/16"	1"	59.16
BPM-JIM-90C-2017	1.1/16"	1.1/4"	116.96
BPM-JIM-90C-1221	1.5/16"	3/4"	63.23
BPM-JIM-90C-1621	1.5/16"	1"	58.95
BPM-JIM-90C-2021	1.5/16"	1.1/4"	112.05
BPM-JIM-90C-2026	1.5/8"	1.1/4"	97.51
BPM-JIM-90C-2430	1.7/8"	1.1/2"	196.40

## ADAPTOR - 90° ELBOW (M X M)

Continued...

### JIC Male x BSPT Male - 90° Elbow

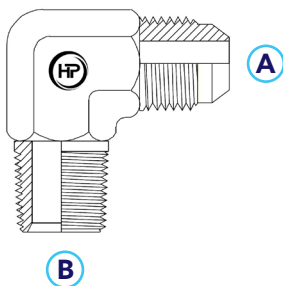

Part Number	A JIC (M)	B BSPT (M)	List Price (\$)
BTM-JIM-90C-0207	7/16"	1/8"	13.46
BTM-JIM-90C-0407	7/16"	1/4"	12.26
BTM-JIM-90C-0607	7/16"	3/8"	15.41
BTM-JIM-90C-0807	7/16"	1/2"	24.09
BTM-JIM-90C-0208	1/2"	1/8"	17.31
BTM-JIM-90C-0408	1/2"	1/4"	13.99
BTM-JIM-90C-0608	1/2"	3/8"	17.82
BTM-JIM-90C-0209	9/16"	1/8"	15.78
BTM-JIM-90C-0409	9/16"	1/4"	12.51
BTM-JIM-90C-0609	9/16"	3/8"	13.21
BTM-JIM-90C-0809	9/16"	1/2"	18.45

Continued on the following page...



## ADAPTOR - 90° ELBOW (M X M)

...Continued

### JIC Male x BSPT Male - 90° Elbow

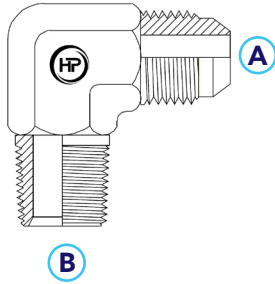

BTM-JIM-90C-1209	9/16"	3/4"	34.25
BTM-JIM-90C-0412	3/4"	1/4"	14.73
BTM-JIM-90C-0612	3/4"	3/8"	12.00
BTM-JIM-90C-0812	3/4"	1/2"	13.8
BTM-JIM-90C-1212	3/4"	3/4"	23.25
BTM-JIM-90C-1612	3/4"	1"	39.20
BTM-JIM-90C-0614	7/8"	3/8"	20.04
BTM-JIM-90C-0814	7/8"	1/2"	14.63
BTM-JIM-90C-1214	7/8"	3/4"	22.81
BTM-JIM-90C-1614	7/8"	1"	42.77
BTM-JIM-90C-0817	1.1/16"	1/2"	27.27
BTM-JIM-90C-1217	1.1/16"	3/4"	21.96
BTM-JIM-90C-1617	1.1/16"	1"	32.46
BTM-JIM-90C-1221	1.5/16"	3/4"	32.88
BTM-JIM-90C-1621	1.5/16"	1"	27.39
BTM-JIM-90C-2021	1.5/16"	1.1/4"	62.32
BTM-JIM-90C-1626	1.5/8"	1"	75.44
BTM-JIM-90C-2026	1.5/8"	1.1/4"	66.97
BTM-JIM-90C-2030	1.7/8"	1.1/4"	166.32
BTM-JIM-90C-2430	1.7/8"	1.1/2"	139.69
BTM-JIM-90C-3240	2.1/2"	2"	265.96

## ADAPTOR - 90° ELBOW (M X M)

Continued...

### JIC Male x UNO Male - 90° Elbow

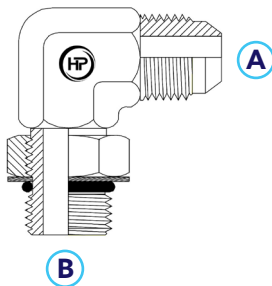

Part Number	A JIC (M)	B UNO (M)	List Price (\$)
JIM-UNM-90C-0708	7/16"	1/2"	24.21
JIM-UNM-90C-0709	7/16"	9/16"	19.36
JIM-UNM-90C-0712	7/16"	3/4"	17.17
JIM-UNM-90C-0907	9/16"	9/16"	17.19
JIM-UNM-90C-0908	9/16"	3/4"	32.19
JIM-UNM-90C-0909	9/16"	7/8"	15.39
JIM-UNM-90C-0912	9/16"	1.1/16"	18.14
JIM-UNM-90C-0914	3/4"	9/16"	26.41
JIM-UNM-90C-0917	3/4"	3/4"	40.41
JIM-UNM-90C-1209	3/4"	7/8"	19.87
JIM-UNM-90C-1212	3/4"	1.1/16"	16.93
JIM-UNM-90C-1214	3/4"	1.5/16"	21.41
JIM-UNM-90C-1217	7/8"	3/4"	34.72
JIM-UNM-90C-1221	3/4"	1.5/16"	12.21
JIM-UNM-90C-1412	7/8"	3/4"	22.28
JIM-UNM-90C-1414	7/8"	7/8"	21.89

Continued on the following page...

## ADAPTOR - 90° ELBOW (M X M)

...Continued

### JIC Male x UNO Male - 90° Elbow

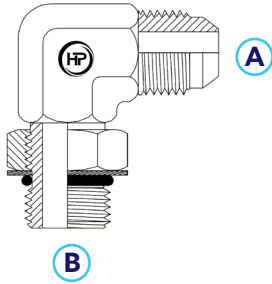

JIM-UNM-90C-1417	1.1/16"	7/8"	31.96
JIM-UNM-90C-1712	1.1/16"	1.1/16"	43.24
JIM-UNM-90C-1714	1.1/16"	1.5/16"	30.76
JIM-UNM-90C-1717	1.5/16"	1.1/16"	27.49
JIM-UNM-90C-1721	1.5/16"	1.5/16"	43.33
JIM-UNM-90C-2117	1.5/16"	1.5/8"	41.31
JIM-UNM-90C-2121	1.5/8"	1.5/16"	39.46
JIM-UNM-90C-2116	1.5/8"	1.5/8"	91.78
JIM-UNM-90C-2621	1.7/8"	1.7/8"	75.58
JIM-UNM-90C-2626	1.5/8"	1.5/8"	86.75
JIM-UNM-90C-3030	1.7/8"	1.7/8"	143.60
JIM-UNM-90C-4040	2.1/2"	2.1/2"	450.55

## ADAPTOR - 90° ELBOW (M X M)

### JIC Male x UNO Male - Extended 90° Elbow

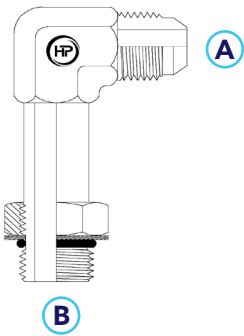

Part Number	A JIC (M)	B UNO (M)	List Price (\$)
JIM-UNM-90C-0909E53	9/16"	9/16"	37.25
JIM-UNM-90C-1212E63	3/4"	3/4"	62.10
JIM-UNM-90C-1214E73	3/4"	7/8"	68.20
JIM-UNM-90C-1414E73	7/8"	7/8"	79.50
JIM-UNM-90C-1717E	1.1/16"	1.1/16"	POA
JIM-UNM-90C-2121E	1.5/16"	1.5/16"	POA

## ADAPTOR - 90° ELBOW (M X M)

### JIC Male x JIC Male - 90° Elbow

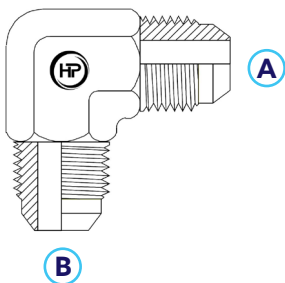

Part Number	A JIC (M)	B JIC (M)	List Price (\$)
JIM-JIM-90C-0707	7/16"	7/16"	11.13
JIM-JIM-90C-0808	1/2"	1/2"	15.11
JIM-JIM-90C-0909	9/16"	9/16"	11.76
JIM-JIM-90C-0912	3/4"	9/16"	17.33
JIM-JIM-90C-1212	3/4"	3/4"	11.13
JIM-JIM-90C-1214	7/8"	3/4"	19.98
JIM-JIM-90C-1414	7/8"	7/8"	16.49
JIM-JIM-90C-1417	1.1/16"	7/8"	25.19
JIM-JIM-90C-1717	1.1/16"	1.1/16"	20.55
JIM-JIM-90C-1721	1.5/16"	1.1/16"	36.83
JIM-JIM-90C-2121	1.5/16"	1.5/16"	34.30
JIM-JIM-90C-2626	1.5/8"	1.5/8"	82.63
JIM-JIM-90C-3030	1.7/8"	1.7/8"	132.43
JIM-JIM-90C-4040	2.1/2"	2.1/2"	216.22

## ADAPTOR - 90° ELBOW (M X M)

### BSPP Male x BSPP Male - 90° Elbow

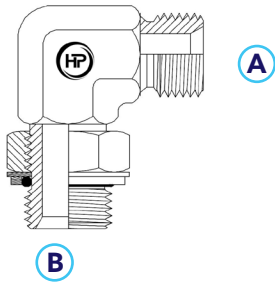

Part Number	A BSPP (M)	B BSPP (M)	List Price (\$)
BPM-BPM-90C-1212	3/4"	3/4"	76.35
BPM-BPM-90C-1616	1"	1"	107.03
BPM-BPM-90C-2020	1.1/4"	1.1/4"	321.33

## ADAPTOR - 90° ELBOW (M X M)

### BSPT Male x BSPT Male - 90° Elbow

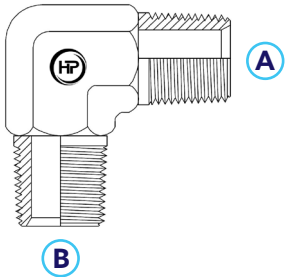

Part Number	A BSPT (M)	B BSPT (M)	List Price (\$)
BTM-BTM-90C-0202	1/8"	1/8"	9.62
BTM-BTM-90C-0204	1/4"	1/8"	11.78
BTM-BTM-90C-0404	1/4"	1/4"	11.38
BTM-BTM-90C-0406	3/8"	1/4"	13.75
BTM-BTM-90C-0606	3/8"	3/8"	13.28
BTM-BTM-90C-0408	1/2"	1/4"	15.03
BTM-BTM-90C-0608	1/2"	3/8"	19.21
BTM-BTM-90C-0808	1/2"	1/2"	16.12
BTM-BTM-90C-0812	3/4"	1/2"	25.44
BTM-BTM-90C-1212	3/4"	3/4"	23.07
BTM-BTM-90C-1216	1"	3/4"	35.01
BTM-BTM-90C-1616	1"	1"	33.48
BTM-BTM-90C-1220	1.1/4"	3/4"	75.32
BTM-BTM-90C-1620	1.1/4"	1"	62.16
BTM-BTM-90C-2020	1.1/4"	1.1/4"	61.69
BTM-BTM-90C-2424	1.1/2"	1.1/2"	130.71
BTM-BTM-90C-3232	2"	2"	279.69

## ADAPTOR - 90° ELBOW (M X M)

Continued...

### BSPT Male x BSPP Male - 90° Elbow

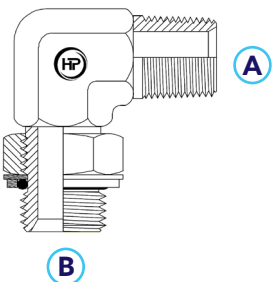

Part Number	A BSPT (M)	B BSPP (M)	List Price (\$)
BPM-BTM-90C-0404	1/4"	1/4"	24.09
BPM-BTM-90C-0604	1/4"	3/8"	30.00
BPM-BTM-90C-0606	3/8"	3/8"	25.96
BPM-BTM-90C-0806	3/8"	1/2"	49.25
BPM-BTM-90C-0608	1/2"	3/8"	39.47
BPM-BTM-90C-0808	1/2"	1/2"	35.28
BPM-BTM-90C-1208	1/2"	3/4"	62.01
BPM-BTM-90C-0812	3/4"	1/2"	47.47
BPM-BTM-90C-1212	3/4"	3/4"	43.60

Continued on the following page...

## ADAPTOR - 90° ELBOW (M X M)

Continued...

### BSPT Male x BSPP Male - 90° Elbow

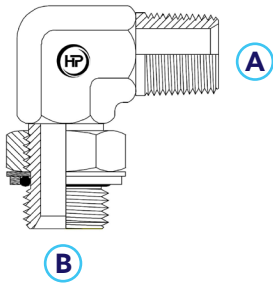

BPM-BTM-90C-1612	3/4"	1"	84.84
BPM-BTM-90C-1216	1"	3/4"	79.30
BPM-BTM-90C-1616	1"	1"	73.40
BPM-BTM-90C-2016	1"	1.1/4"	143.46
BPM-BTM-90C-2020	1.1/4"	1.1/4"	128.93
BPM-BTM-90C-2424	1.1/2"	1.1/2"	155.50

## ADAPTOR - 90° ELBOW (M X M)

### BSPT Male x UNO Male - 90° Elbow

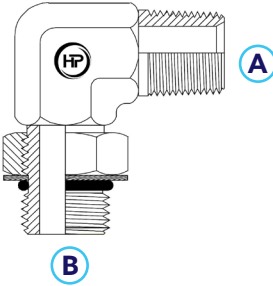

Part Number	A BSPT (M)	B UNO (M)	List Price (\$)
BTM-UNM-90C-0407	1/4"	7/16"	14.85
BTM-UNM-90C-0409	1/4"	9/16"	14.95
BTM-UNM-90C-0412	1/4"	3/4"	27.27
BTM-UNM-90C-0609	3/8"	9/16"	20.02
BTM-UNM-90C-0612	3/8"	3/4"	27.27
BTM-UNM-90C-0614	3/8"	7/8"	31.48
BTM-UNM-90C-0812	1/2"	3/4"	27.27
BTM-UNM-90C-0814	1/2"	7/8"	31.01
BTM-UNM-90C-0817	1/2"	1.1/16"	32.91
BTM-UNM-90C-1214	3/4"	7/8"	33.15
BTM-UNM-90C-1217	3/4"	1.1/16"	31.96
BTM-UNM-90C-1221	3/4"	1.5/16"	66.29
BTM-UNM-90C-1617	1"	1.1/16"	67.24
BTM-UNM-90C-1621	1"	1.5/16"	64.63
BTM-UNM-90C-1626	1"	1.5/8"	81.73
BTM-UNM-90C-2026	1.1/4"	1.5/8"	82.57

## ADAPTOR - 90° ELBOW (M X F)

### UNO Male x JIC Female Swivel - 90° Elbow

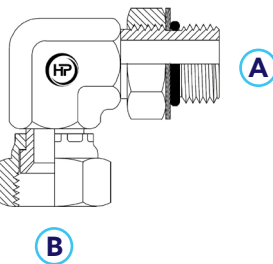

Part Number	A UNO (M)	B JIC (FS)	List Price (\$)
JIF-UNM-90C-0707	7/16"	7/16"	30.00
JIF-UNM-90C-0909	9/16"	9/16"	25.92
JIF-UNM-90C-1212	3/4"	3/4"	30.97
JIF-UNM-90C-1412	3/4"	7/8"	37.84
JIF-UNM-90C-1414	7/8"	7/8"	39.12
JIF-UNM-90C-1717	1.1/16"	1.1/16"	49.37
JIF-UNM-90C-2121	1.5/16"	1.5/16"	99.08

## ADAPTOR - 90° ELBOW (M X F)

### JIC Male x JIC Female Swivel - 90° Elbow

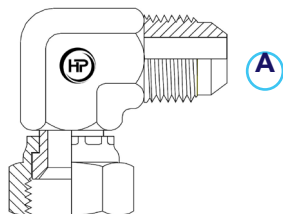

Part Number	A JIC (M)	B JIC (FS)	List Price (\$)
JIM-JIF-90C-0707	7/16"	7/16"	13.05
JIM-JIF-90C-0808	1/2"	1/2"	16.75
JIM-JIF-90C-0909	9/16"	9/16"	14.64
JIM-JIF-90C-0912	9/16"	3/4"	19.19
JIM-JIF-90C-1209	3/4"	9/16"	19.13
JIM-JIF-90C-1212	3/4"	3/4"	18.24
JIM-JIF-90C-1214	3/4"	7/8"	29.65
JIM-JIF-90C-1414	7/8"	7/8"	21.50
JIM-JIF-90C-1417	7/8"	1.1/16"	33.38
JIM-JIF-90C-1714	1.1/16"	7/8"	27.92
JIM-JIF-90C-1717	1.1/16"	1.1/16"	26.97
JIM-JIF-90C-1919	1.5/16"	1.5/16"	58.92
JIM-JIF-90C-2121	1.5/8"	1.5/8"	50.52
JIM-JIF-90C-2626	1.7/8"	1.7/8"	97.38
JIM-JIF-90C-3030	2.1/2"	2.1/2"	233.46
JIM-JIF-90C-4040	2.1/2"	2.1/2"	355.43

## ADAPTOR - 90° ELBOW (M X F)

### JIC Male x JIC Female Swivel - 90° Bend

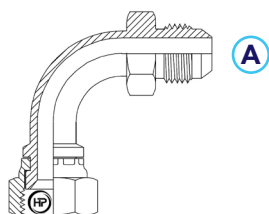

Part Number	A JIC (M)	B JIC (FS)	List Price (\$)
JIM-JIF-90S-0707	7/16"	7/16"	22.93
JIM-JIF-90S-0909	9/16"	9/16"	29.67
JIM-JIF-90S-1212	3/4"	3/4"	37.56
JIM-JIF-90S-1414	7/8"	7/8"	47.40
JIM-JIF-90S-1717	1.1/16"	1.1/16"	67.69
JIM-JIF-90S-2121	1.5/16"	1.5/16"	75.27
JIM-JIF-90S-2626	1.5/8"	1.5/8"	152.73
JIM-JIF-90S-3030	1.7/8"	1.7/8"	257.68
JIM-JIF-90S-4040	2.1/2"	2.1/2"	453.17

## ADAPTOR - 90° ELBOW (M X F)

### JIC Male x JIC Female Swivel - 90° Long Bend

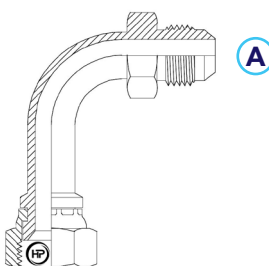

Part Number	A JIC (M)	B JIC (FS)	List Price (\$)
JIM-JIF-90S-0707L	7/16"	7/16"	35.76
JIM-JIF-90S-0909L	9/16"	9/16"	39.54
JIM-JIF-90S-1212L	3/4"	3/4"	46.81
JIM-JIF-90S-14147L	7/8"	7/8"	54.92
JIM-JIF-90S-1717L	1.1/16"	1.1/16"	67.31
JIM-JIF-90S-2121L	1.5/16"	1.5/16"	107.13
JIM-JIF-90S-2626L	1.5/8"	1.5/8"	169.05

## ADAPTOR - 90° ELBOW (M X F)

### BSPP Male x BSPP Female Swivel - 90° Elbow

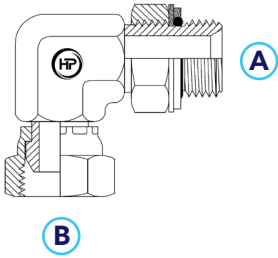

Part Number	A BSPP (M)	B BSPP (FS)	List Price (\$)
BPM-BSF-90C-0404	1/4"	1/4"	44.67
BPM-BSF-90C-0606	3/8"	3/8"	48.32
BPM-BSF-90C-0808	1/2"	1/2"	56.61
BPM-BSF-90C-1212	3/4"	3/4"	72.86
BPM-BSF-90C-1616	1"	1"	96.85
BPM-BSF-90C-2020	1.1/4"	1.1/4"	287.97

## ADAPTOR - 90° ELBOW (M X F)

### BSPT Male x BSPP Female Swivel - 90° Elbow

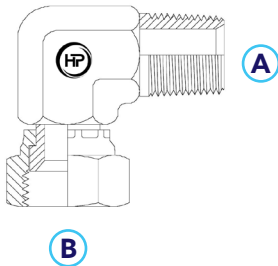

Part Number	A BSPT (M)	B BSPP (FS)	List Price (\$)
BTM-BSF-90C-0202	1/8"	1/8"	14.8
BTM-BSF-90C-0404	1/4"	1/4"	16.43
BTM-BSF-90C-0604	3/8"	1/4"	25.63
BTM-BSF-90C-0606	3/8"	3/8"	19.90
BTM-BSF-90C-0608	3/8"	1/2"	26.82
BTM-BSF-90C-0806	1/2"	3/8"	30.36
BTM-BSF-90C-0808	1/2"	1/2"	21.17
BTM-BSF-90C-0812	1/2"	3/4"	72.44
BTM-BSF-90C-1212	3/4"	3/4"	31.45
BTM-BSF-90C-1616	1"	1"	44.64
BTM-BSF-90C-2020	1.1/4"	1.1/4"	128.25
BTM-BSF-90C-2424	1.1/2"	1.1/2"	196.14

## ADAPTOR - 90° ELBOW (M X F)

### UNO Male x BSPP Female Swivel - 90° Elbow

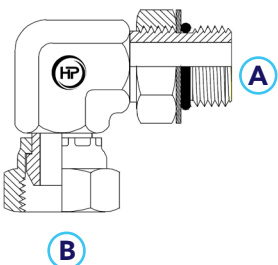

Part Number	A UNO (M)	B BSPP (FS)	List Price (\$)
BSF-UNM-90C-0207	7/16"	1/8"	45.38
BSF-UNM-90C-0407	7/16"	1/4"	46.33
BSF-UNM-90C-0409	9/16"	1/4"	56.38
BSF-UNM-90C-0609	9/16"	3/8"	45.14
BSF-UNM-90C-0612	3/4"	3/8"	42.17
BSF-UNM-90C-0812	3/4"	1/2"	38.08
BSF-UNM-90C-0814	7/8"	1/2"	43.24
BSF-UNM-90C-1217	1.1/16"	3/4"	61.72
BSF-UNM-90C-1621	1.5/16"	1"	79.95

## ADAPTOR - 90° ELBOW (M X F)

### BSPT Male x BSPT Female - 90° Elbow Fixed

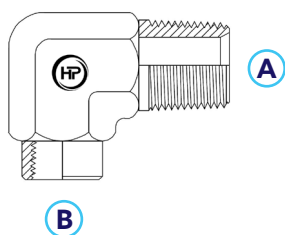

Part Number	A BSPT (M)	B BSPT (F)	List Price (\$)
BTM-BTF-90C-0202	1/8"	1/8"	13.09
BTM-BTF-90C-0404	1/4"	1/4"	15.12
BTM-BTF-90C-0606	3/8"	3/8"	16.07
BTM-BTF-90C-0808	1/2"	1/2"	20.23
BTM-BTF-90C-1212	3/4"	3/4"	32.22
BTM-BTF-90C-1616	1"	1"	65.49
BTM-BTF-90C-2020	1.1/4"	1.1/4"	114.50

## ADAPTOR - 90° ELBOW (F X F)

### BSPT Female x BSPT Female - 90° Elbow Fixed

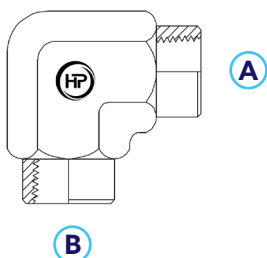

Part Number	A BSPT (F)	B BSPT (F)	List Price (\$)
BTF-BTF-90C-0202	1/8"	1/8"	13.52
BTF-BTF-90C-0404	1/4"	1/4"	17.13
BTF-BTF-90C-0606	3/8"	3/8"	18.15
BTF-BTF-90C-0808	1/2"	1/2"	27.41
BTF-BTF-90C-1212	3/4"	3/4"	33.62
BTF-BTF-90C-1616	1"	1"	63.44
BTF-BTF-90C-2020	1.1/4"	1.1/4"	140.15
BTF-BTF-90C-2424	1.1/2"	1.1/2"	217.17
BTF-BTF-90C-3232	2"	2"	536.09

JICM X BSPPM  
45° ELBOW (M X M)

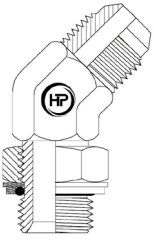

Page 47

JICM X BSPTM  
45° ELBOW (M X M)

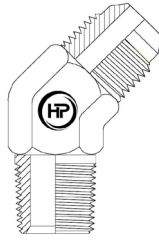

Page 47

JICM X UNOM  
45° ELBOW (M X M)

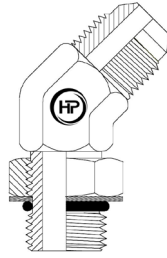

Page 48

JICM X JICM  
45° ELBOW (M X M)

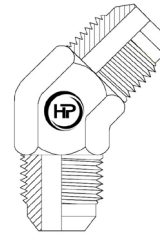

Page 48

BSPTM X BSPTM  
45° ELBOW (M X M)

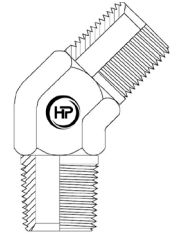

Page 48

BSPTM X UNOM  
45° ELBOW (M X M)

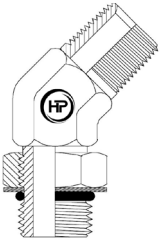

Page 49

JICM X JICF  
45° ELBOW (M X F)

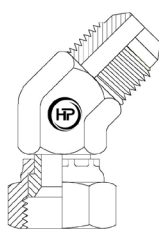

Page 49

JICM X JICF  
45° BEND (M X F)

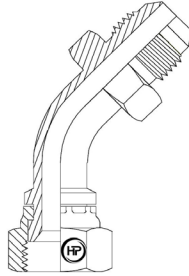

Page 49

BSPTM X BSPPF  
45° ELBOW (M X F)

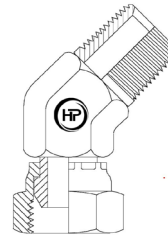

Page 50

BSPTM X BSPTF  
REDUCING BUSH (M X F)

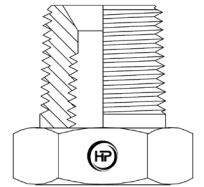

Page 50

BSPPM X BSPPF  
REDUCING BUSH (M X F)

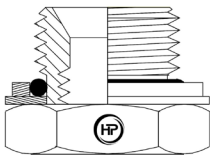

Page 51

UNOM X BSPTF  
REDUCING BUSH (M X F)

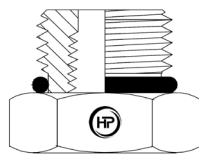

Page 51

*For other sizes and thread types please contact us*



## ADAPTOR - 45° ELBOW (M X M)

### JIC Male x BSPP Male - 45° Elbow

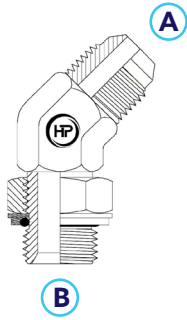

Part Number	A JIC (M)	B BSPP (M)	List Price (\$)
BPM-JIM-45C-0407	7/16"	1/4"	30.36
BPM-JIM-45C-0607	7/16"	3/8"	52.89
BPM-JIM-45C-0409	9/16"	1/4"	30.68
BPM-JIM-45C-0609	9/16"	3/8"	35.61
BPM-JIM-45C-0809	9/16"	1/2"	43.04
BPM-JIM-45C-0612	3/4"	3/8"	31.01
BPM-JIM-45C-0812	3/4"	1/2"	41.64
BPM-JIM-45C-0814	7/8"	1/2"	42.79
BPM-JIM-45C-1214	7/8"	3/4"	47.52
BPM-JIM-45C-1217	1.1/16"	3/4"	54.38
BPM-JIM-45C-1621	1.5/16"	1"	68.29

## ADAPTOR - 45° ELBOW (M X M)

### JIC Male x BSPT Male - 45° Elbow

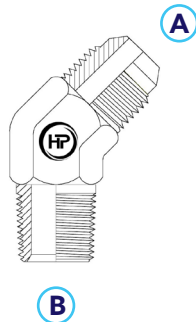

Part Number	A JIC (M)	B BSPT (M)	List Price (\$)
BTM-JIM-45C-0207	7/16"	1/8"	15.21
BTM-JIM-45C-0704	7/16"	1/4"	16.73
BTM-JIM-45C-0408	1/2"	1/4"	44.61
BTM-JIM-45C-0209	9/16"	1/8"	18.87
BTM-JIM-45C-0409	9/16"	1/4"	18.67
BTM-JIM-45C-0609	9/16"	3/8"	23.43
BTM-JIM-45C-0809	9/16"	1/2"	29.55
BTM-JIM-45C-0412	3/4"	1/4"	30.09
BTM-JIM-45C-0612	3/4"	3/8"	24.15
BTM-JIM-45C-0812	3/4"	1/2"	27.83
BTM-JIM-45C-1212	3/4"	3/4"	52.98
BTM-JIM-45C-0614	7/8"	3/8"	32.41
BTM-JIM-45C-0814	7/8"	1/2"	29.79
BTM-JIM-45C-1214	7/8"	3/4"	39.56
BTM-JIM-45C-0817	1.1/16"	1/2"	41.02
BTM-JIM-45C-1217	1.1/16"	3/4"	36.71
BTM-JIM-45C-1221	1.5/16"	3/4"	56.97
BTM-JIM-45C-1621	1.5/16"	1"	45.94
BTM-JIM-45C-2026	1.5/8"	1.1/4"	87.06
BTM-JIM-45C-2430	1.7/8"	1.1/2"	197.51

## ADAPTOR - 45° ELBOW (M X M)

### JIC Male x UNO Male - 45° Elbow

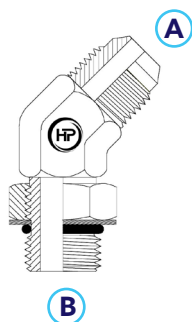

Part Number	A JIC (M)	B UNO (M)	List Price (\$)
JIM-UNM-45C-0707	7/16"	7/16"	20.29
JIM-UNM-45C-0709	7/16"	9/16"	27.09
JIM-UNM-45C-0909	9/16"	9/16"	25.34
JIM-UNM-45C-0912	9/16"	3/4"	30.55
JIM-UNM-45C-1209	3/4"	9/16"	30.14
JIM-UNM-45C-1212	3/4"	3/4"	32.62
JIM-UNM-45C-1214	3/4"	7/8"	34.45
JIM-UNM-45C-1217	3/4"	1.1/16"	43.39
JIM-UNM-45C-1412	7/8"	3/4"	34.06
JIM-UNM-45C-1414	7/8"	7/8"	36.27
JIM-UNM-45C-1717	1.1/16"	1.1/16"	38.71
JIM-UNM-45C-2121	1.5/16"	1.5/16"	63.32
JIM-UNM-45C-2626	1.5/8"	1.5/8"	103.24
JIM-UNM-45C-3030	1.7/8"	1.7/8"	209.65

## ADAPTOR - 45° ELBOW (M X M)

### JIC Male x JIC Male - 45° Elbow

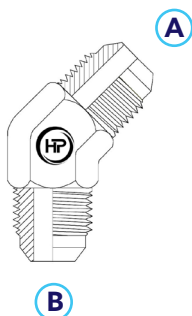

Part Number	A JIC (M)	B JIC (M)	List Price (\$)
JIM-JIM-45C-0707	7/16"	7/16"	11.31
JIM-JIM-45C-0808	1/2"	1/2"	29.85
JIM-JIM-45C-0909	9/16"	9/16"	11.31
JIM-JIM-45C-1212	3/4"	3/4"	14.39
JIM-JIM-45C-1414	7/8"	7/8"	16.97
JIM-JIM-45C-1717	1.1/16"	1.1/16"	33.93
JIM-JIM-45C-2121	1.5/16"	1.5/16"	39.92
JIM-JIM-45C-2626	1.5/8"	1.5/8"	131.55

## ADAPTOR - 45° ELBOW (M X M)

### BSPT Male x BSPT Male - 45° Elbow

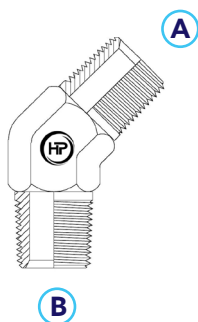

Part Number	A BSPT (M)	B BSPT (M)	List Price (\$)
BTM-BTM-45C-0202	1/8"	1/8"	22.60
BTM-BTM-45C-0404	1/4"	1/4"	19.07
BTM-BTM-45C-0406	3/8"	1/4"	18.77
BTM-BTM-45C-0606	3/8"	3/8"	18.48
BTM-BTM-45C-0608	1/2"	3/8"	31.04
BTM-BTM-45C-0808	1/2"	1/2"	23.88
BTM-BTM-45C-0812	3/4"	1/2"	39.42
BTM-BTM-45C-1212	3/4"	3/4"	33.30
BTM-BTM-45C-1216	1"	3/4"	54.26
BTM-BTM-45C-1616	1"	1"	42.80

## ADAPTOR - 45° ELBOW (M X M)

### BSPT Male x UNO Male - 45° Elbow

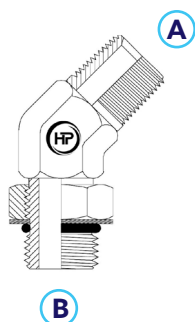

Part Number	A BSPT (M)	B UNO (M)	List Price (\$)
BTM-UNM-45C-0409	1/4"	9/16"	23.76
BTM-UNM-45C-0609	3/8"	9/16"	28.51
BTM-UNM-45C-0612	3/8"	3/4"	30.89
BTM-UNM-45C-0812	1/2"	3/4"	34.45
BTM-UNM-45C-0814	1/2"	7/8"	45.52
BTM-UNM-45C-1217	3/4"	1.1/16"	41.58
BTM-UNM-45C-1621	1"	1.5/16"	59.40

## ADAPTOR - 45° ELBOW (M X F)

### JIC Male x JIC Female Swivel - 45° Elbow

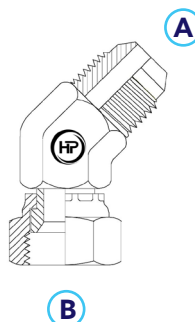

Part Number	A JIC (M)	B JIC (FS)	List Price (\$)
JIM-JIF-45C-0707	7/16"	7/16"	22.08
JIM-JIF-45C-0808	1/2"	1/2"	25.93
JIM-JIF-45C-0909	9/16"	9/16"	17.96
JIM-JIF-45C-1212	3/4"	3/4"	21.23
JIM-JIF-45C-1414	7/8"	7/8"	26.83
JIM-JIF-45C-1717	1.1/16"	1.1/16"	30.20
JIM-JIF-45C-2121	1.5/16"	1.5/16"	44.50
JIM-JIF-45C-2626	1.5/8"	1.5/8"	105.16
JIM-JIF-45C-3030	1.7/8"	1.7/8"	151.23
JIM-JIF-45C-4040	2.1/2"	2.1/2"	333.08

## ADAPTOR - 45° ELBOW (M X F)

### JIC Male x JIC Female Swivel - 45° Bend

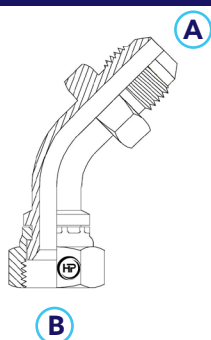

Part Number	A JIC (M)	B JIC (FS)	List Price (\$)
JIM-JIF-45S-0909	9/16"	9/16"	44.16
JIM-JIF-45S-1212	3/4"	3/4"	49.99
JIM-JIF-45S-1414	7/8"	7/8"	58.48
JIM-JIF-45S-1717	1.1/16"	1.1/16"	61.39
JIM-JIF-45S-2121	1.5/16"	1.5/16"	83.52
JIM-JIF-45S-2626	1.5/8"	1.5/8"	126.17

## ADAPTOR - 45° ELBOW (M X F)

### BSPT Male x BSPP Female Swivel - 45° Elbow

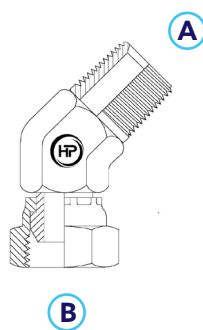

Part Number	A BSPT (M)	B BSPP (FS)	List Price (\$)
BTM-BSF-45C-0202	1/8"	1/8"	21.92
BTM-BSF-45C-0404	1/4"	1/4"	19.52
BTM-BSF-45C-0606	3/8"	3/8"	24.62
BTM-BSF-45C-0808	1/2"	1/2"	31.38
BTM-BSF-45C-1212	3/4"	3/4"	49.74
BTM-BSF-45C-1616	1"	1"	60.83
BTM-BSF-45C-2020	1.1/4"	1.1/4"	116.67
BTM-BSF-45C-2424	1.1/2"	1.1/2"	165.84

## ADAPTOR - REDUCING BUSH

### BSPT Male x BSPT Female - Reducing Bush

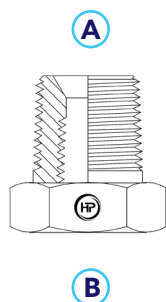

Part Number	A BSPT (M)	B BSPT (F)	List Price (\$)
BTM-BTF-0402	1/4"	1/8"	9.62
BTM-BTF-0602	3/8"	1/8"	6.58
BTM-BTF-0604	3/8"	1/4"	5.49
BTM-BTF-0802	1/2"	1/8"	11.23
BTM-BTF-0804	1/2"	1/4"	8.14
BTM-BTF-0806	1/2"	3/8"	5.80
BTM-BTF-1204	3/4"	1/4"	10.57
BTM-BTF-1206	3/4"	3/8"	10.16
BTM-BTF-1208	3/4"	1/2"	9.84
BTM-BTF-1606	1"	3/8"	24.06
BTM-BTF-1608	1"	1/2"	13.09
BTM-BTF-1612	1"	3/4"	13.76
BTM-BTF-2008	1.1/4"	1/2"	32.53
BTM-BTF-2012	1.1/4"	3/4"	24.67
BTM-BTF-2016	1.1/4"	1"	27.69
BTM-BTF-2408	1.1/2"	1/2"	35.64
BTM-BTF-2412	1.1/2"	3/4"	36.00
BTM-BTF-2416	1.1/2"	1"	37.10
BTM-BTF-2420	1.1/2"	1.1/4"	38.20
BTM-BTF-3216	2"	1"	69.99
BTM-BTF-3220	2"	1.1/4"	67.15
BTM-BTF-3224	2"	1.1/2"	67.14

## ADAPTOR - REDUCING BUSH

### BSPM Male x BSPP Female - Reducing Bush

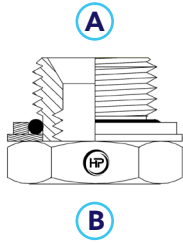

Part Number	A BSPP (M)	B BSPP (F)	List Price (\$)
BPM-BPF-0402	1/4"	1/8"	19.69
BPM-BPF-0604	3/8"	1/4"	16.06
BPM-BPF-0804	1/2"	1/4"	16.51
BPM-BPF-0806	1/2"	3/8"	17.27
BPM-BPF-1204	3/4"	1/4"	24.66
BPM-BPF-1206	3/4"	3/8"	19.48
BPM-BPF-1208	3/4"	1/2"	16.93
BPM-BPF-1608	1"	1/2"	26.96
BPM-BPF-1612	1"	3/4"	37.99
BPM-BPF-2008	1.1/4"	1/2"	49.90
BPM-BPF-2012	1.1/4"	3/4"	74.98
BPM-BPF-2016	1.1/4"	1"	48.86
BPM-BPF-2416	1.1/2"	1"	81.94
BPM-BPF-2420	1.1/2"	1.1/4"	86.28
BPM-BPF-3224	2"	1.1/2"	161.19

## ADAPTOR - REDUCING BUSH

### UNO Male x BSPT Female - Reducing Bush

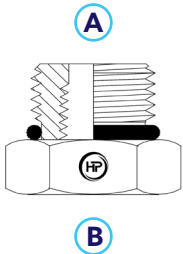

Part Number	A UNO (M)	B BSPT (F)	List Price (\$)
BTF-UNM-0209	9/16"	1/8"	16.63
BTF-UNM-0212	3/4"	1/8"	38.85
BTF-UNM-0412	3/4"	1/4"	58.33
BTF-UNM-0612	3/4"	3/8"	57.62
BTF-UNM-0414	7/8"	1/4"	64.39
BTF-UNM-0614	7/8"	3/8"	63.56
BTF-UNM-0817	1.1/16"	1/2"	31.78
BTF-UNM-0821	1.5/16"	1/2"	56.02
BTF-UNM-1221	1.5/16"	3/4"	104.07
BTF-UNM-1226	1.5/8"	3/4"	107.70

JICM X BSPPM X JICM  
RUN TEE

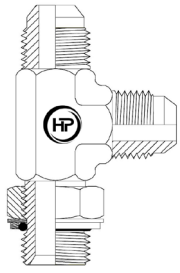

Page 53

JICM X BSPTM X JICM  
RUN TEE

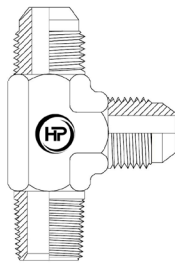

Page 53

JICM X UNOM X JICM  
RUN TEE

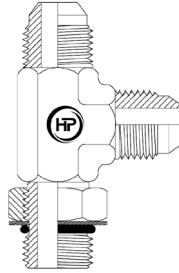

Page 53

JICM X JICF X JICM  
RUN TEE

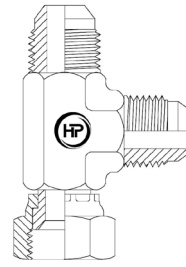

Page 54

BSPPM X BSPPF X BSPPM  
RUN TEE

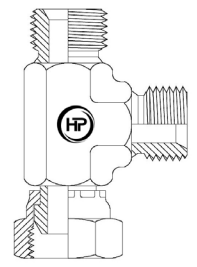

Page 54

BSPTM X BSPPF X BSPTM  
RUN TEE

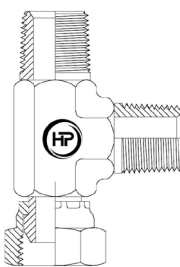

Page 54

BSPTM X BSPPM X BSPTM  
RUN TEE

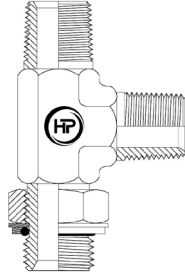

Page 55

BSPTM X BSPTF X BSPTF  
RUN TEE

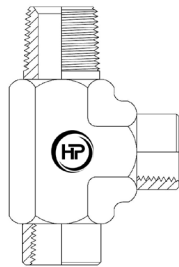

Page 55

JICM X JICM X BSPPM  
BRANCH TEE

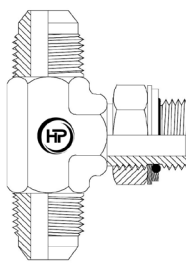

Page 55

JICM X JICM X BSPTM  
BRANCH TEE

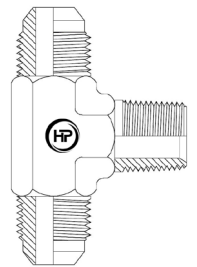

Page 56

JICM X JICM X UNOM  
BRANCH TEE

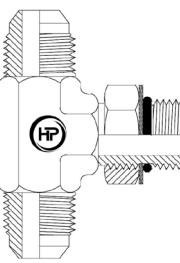

Page 56

JICM X JICM X JICF  
BRANCH TEE

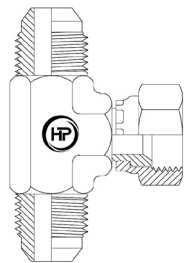

Page 56

BSPPF X BSPPF X BSPTM  
BRANCH TEE

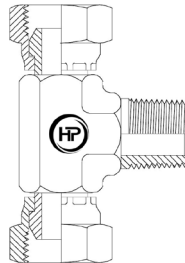

Page 57

BSPTM X BSPTM X BSPPF  
BRANCH TEE

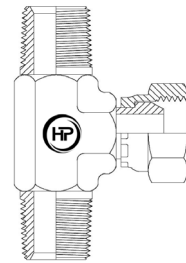

Page 57

JICM X JICM X JICM  
EQUAL TEE

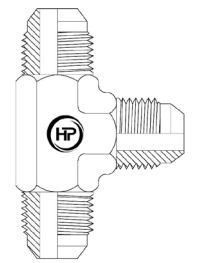

Page 57

BSPPF X BSPPF X BSPPF  
EQUAL TEE

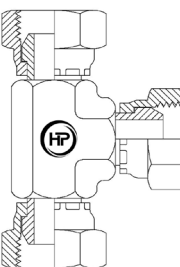

Page 58

BSPTM X BSPTM X BSPTM  
EQUAL TEE

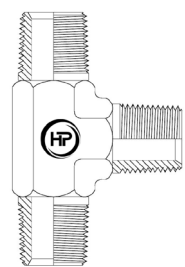

Page 58

BSPTF X BSPTF X BSPTF  
EQUAL TEE

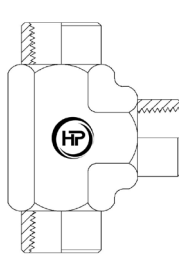

Page 58

*For other sizes and thread types please contact us*

## ADAPTOR - RUN TEE

### JIC Male x BSPP Male x JIC Male - Run Tee

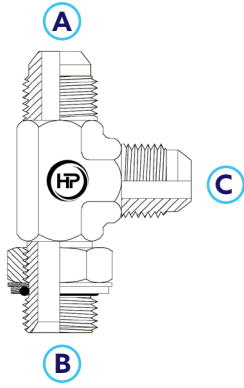

Part Number	A JIC (M)	B BSPP (M)	C JIC (M)	List Price (\$)
JIM-BPM-JIM-070407	7/16"	1/4"	7/16"	39.00
JIM-BPM-JIM-090409	9/16"	1/4"	9/16"	36.80
JIM-BPM-JIM-090609	9/16"	3/8"	9/16"	41.94
JIM-BPM-JIM-120612	3/4"	3/8"	3/4"	41.31
JIM-BPM-JIM-120812	3/4"	1/2"	3/4"	57.33
JIM-BPM-JIM-140814	7/8"	1/2"	7/8"	51.65
JIM-BPM-JIM-171217	1.1/16"	3/4"	1.1/16"	69.38
JIM-BPM-JIM-211621	1.5/16"	1"	1.5/16"	113.84
JIM-BPM-JIM-262026	1.5/8"	1.1/4"	1.5/8"	220.37

## ADAPTOR - RUN TEE

### JIC Male x BSPT Male x JIC Male - Run Tee

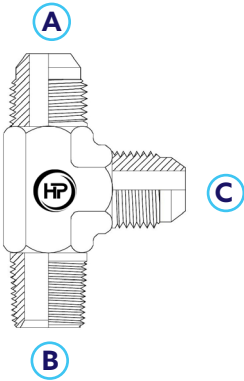

Part Number	A JIC (M)	B BSPT (M)	C JIC (M)	List Price (\$)
JIM-BTM-JIM-070207	7/16"	1/8"	7/16"	28.43
JIM-BTM-JIM-070407	7/16"	1/4"	7/16"	35.64
JIM-BTM-JIM-090409	9/16"	1/4"	9/16"	29.55
JIM-BTM-JIM-090609	9/16"	3/8"	9/16"	39.53
JIM-BTM-JIM-120612	3/4"	3/8"	3/4"	35.02
JIM-BTM-JIM-120812	3/4"	1/2"	3/4"	38.82
JIM-BTM-JIM-140814	7/8"	1/2"	7/8"	39.41
JIM-BTM-JIM-171217	1.1/16"	3/4"	1.1/16"	54.41
JIM-BTM-JIM-211621	1.5/16"	1"	1.5/16"	81.85

## ADAPTOR - RUN TEE

### JIC Male x UNO Male x JIC Male - Run Tee

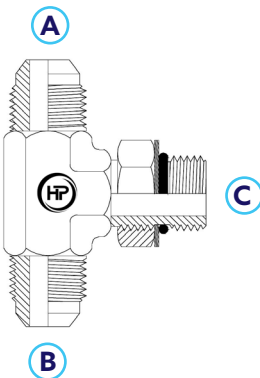

Part Number	A JIC (M)	B UNO (M)	C JIC (M)	List Price (\$)
JIM-UNM-JIM-070707	7/16"	7/16"	7/16"	27.95
JIM-UNM-JIM-090909	9/16"	9/16"	9/16"	23.94
JIM-UNM-JIM-121212	3/4"	3/4"	3/4"	29.85
JIM-UNM-JIM-121412	3/4"	7/8"	3/4"	36.23
JIM-UNM-JIM-141412	7/8"	7/8"	3/4"	36.00
JIM-UNM-JIM-141414	7/8"	7/8"	7/8"	35.13
JIM-UNM-JIM-171717	1.1/16"	1.1/16"	1.1/16"	51.20
JIM-UNM-JIM-212121	1.5/16"	1.5/16"	1.5/16"	86.03
JIM-UNM-JIM-262626	1.5/8"	1.5/8"	1.5/8"	130.71

## ADAPTOR - RUN TEE

### JIC Male x JIC Female Swivel x JIC Male - Run Tee

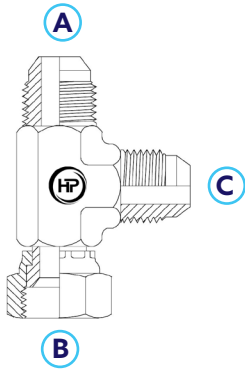

Part Number	A JIC (M)	B JIC (FS)	C JIC (M)	List Price (\$)
JIM-JIF-JIM-070707	7/16"	7/16"	7/16"	17.80
JIM-JIF-JIM-080808	1/2"	1/2"	1/2"	26.44
JIM-JIF-JIM-090909	9/16"	9/16"	9/16"	18.53
JIM-JIF-JIM-121212	3/4"	3/4"	3/4"	22.01
JIM-JIF-JIM-141414	7/8"	7/8"	7/8"	25.69
JIM-JIF-JIM-171717	1.1/16"	1.1/16"	1.1/16"	34.57
JIM-JIF-JIM-212121	1.5/16"	1.5/16"	1.5/16"	61.54
JIM-JIF-JIM-262626	1.5/8"	1.5/8"	1.5/8"	117.97
JIM-JIF-JIM-303030	1.7/8"	1.7/8"	1.7/8"	178.42

## ADAPTOR - RUN TEE

### BSPP Male x BSPP Female Swivel x BSPP Male - Run Tee

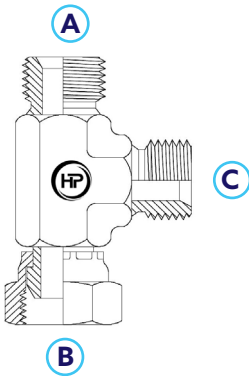

Part Number	A BSPP (M)	B BSPP (FS)	C BSPP (M)	List Price (\$)
BPM-BSF-BPM-040404	1/4"	1/4"	1/4"	59.28
BPM-BSF-BPM-060606	3/8"	3/8"	3/8"	59.28
BPM-BSF-BPM-080808	1/2"	1/2"	1/2"	71.40

## ADAPTOR - RUN TEE

### BSPT Male x BSPP Female Swivel x BSPT Male - Run Tee

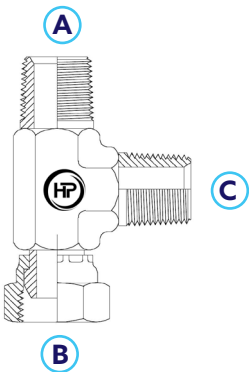

Part Number	A BSPT (M)	B BSPP (FS)	C BSPT (M)	List Price (\$)
BTM-BSF-BTM-020202	1/8"	1/8"	1/8"	23.14
BTM-BSF-BTM-040404	1/4"	1/4"	1/4"	22.87
BTM-BSF-BTM-060606	3/8"	3/8"	3/8"	25.64
BTM-BSF-BTM-080808	1/2"	1/2"	1/2"	29.96
BTM-BSF-BTM-121212	3/4"	3/4"	3/4"	44.52
BTM-BSF-BTM-161616	1"	1"	1"	67.00
BTM-BSF-BTM-202020	1.1/4"	1.1/4"	1.1/4"	130.82



## ADAPTOR - RUN TEE

### BSPT Male x BSPP Male x BSPT Male - Run Tee

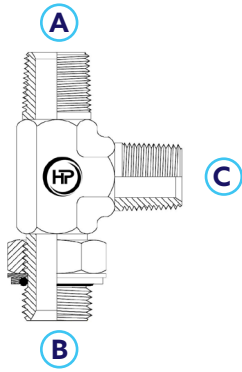

Part Number	A BSPT (M)	B BSPP (M)	C BSPT (M)	List Price (\$)
BTM-BPM-BTM-040404	1/4"	1/4"	1/4"	29.32
BTM-BPM-BTM-060606	3/8"	3/8"	3/8"	31.36
BTM-BPM-BTM-080808	1/2"	1/2"	1/2"	48.71

## ADAPTOR - RUN TEE

### BSPT Male x BSPT Female Fixed x BSPT Female Fixed - Run Tee

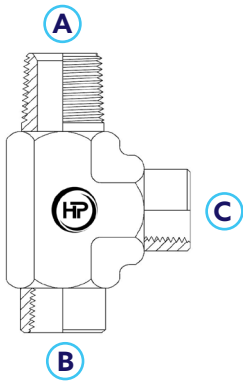

Part Number	A BSPT (M)	B BSPT (F)	C BSPT (F)	List Price (\$)
BTM-BTF-BTF-020202	1/8"	1/8"	1/8"	29.02
BTM-BTF-BTF-040404	1/4"	1/4"	1/4"	23.64
BTM-BTF-BTF-060606	3/8"	3/8"	3/8"	32.91
BTM-BTF-BTF-080808	1/2"	1/2"	1/2"	42.80
BTM-BTF-BTF-121212	3/4"	3/4"	3/4"	68.79
BTM-BTF-BTF-161616	1"	1"	1"	109.80

## ADAPTOR - BRANCH TEE

### JIC Male x JIC Male x BSPP Male - Branch Tee

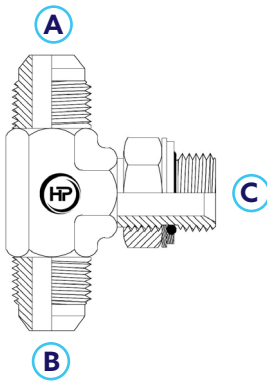

Part Number	A JIC (M)	B JIC (M)	C BSPP (M)	List Price (\$)
JIM-JIM-BPM-070704	7/16"	7/16"	1/4"	36.57
JIM-JIM-BPM-090904	9/16"	9/16"	1/4"	35.73
JIM-JIM-BPM-090906	9/16"	9/16"	3/8"	40.19
JIM-JIM-BPM-121206	3/4"	3/4"	3/8"	48.59
JIM-JIM-BPM-121208	3/4"	3/4"	1/2"	53.22
JIM-JIM-BPM-141408	7/8"	7/8"	1/2"	54.65
JIM-JIM-BPM-141412	7/8"	7/8"	3/4"	100.98
JIM-JIM-BPM-171712	1.1/16"	1.1/16"	3/4"	70.30
JIM-JIM-BPM-212116	1.5/16"	1.5/16"	1"	136.86
JIM-JIM-BPM-262620	1.5/8"	1.5/8"	1.1/4"	233.09

## ADAPTOR - BRANCH TEE

### JIC Male x JIC Male x BSPT Male - Branch Tee

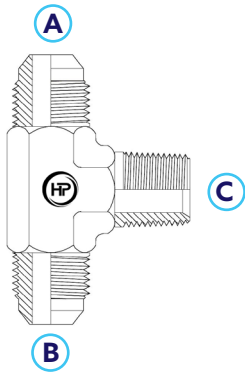

Part Number	A JIC (M)	B JIC (M)	C BSPT (M)	List Price (\$)
JIM-JIM-BTM-070702	7/16"	7/16"	1/8"	21.11
JIM-JIM-BTM-070704	7/16"	7/16"	1/4"	26.97
JIM-JIM-BTM-090904	9/16"	9/16"	1/4"	22.31
JIM-JIM-BTM-090906	9/16"	9/16"	3/8"	28.93
JIM-JIM-BTM-121206	3/4"	3/4"	3/8"	27.44
JIM-JIM-BTM-121208	3/4"	3/4"	1/2"	29.68
JIM-JIM-BTM-141408	7/8"	7/8"	1/2"	30.60
JIM-JIM-BTM-171712	1.1/16"	1.1/16"	3/4"	46.23
JIM-JIM-BTM-171716	1.1/16"	1.1/16"	1"	85.54
JIM-JIM-BTM-212116	1.5/16"	1.5/16"	1"	81.17
JIM-JIM-BTM-262620	1.5/8"	1.5/8"	1.1/4"	142.56

## ADAPTOR - BRANCH TEE

### JIC Male x JIC Male x UNO Male - Branch Tee

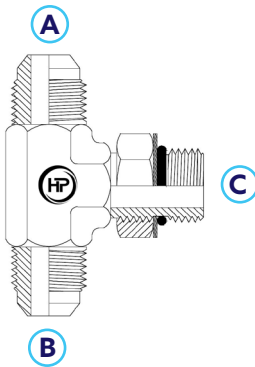

Part Number	A JIC (M)	B JIC (M)	C UNO (M)	List Price (\$)
JIM-JIM-UNM-070707	7/16"	7/16"	7/16"	28.24
JIM-JIM-UNM-090907	9/16"	9/16"	7/16"	22.54
JIM-JIM-UNM-090909	9/16"	9/16"	9/16"	29.96
JIM-JIM-UNM-090912	9/16"	9/16"	3/4"	33.38
JIM-JIM-UNM-121209	3/4"	3/4"	9/16"	27.60
JIM-JIM-UNM-121212	3/4"	3/4"	3/4"	35.78
JIM-JIM-UNM-121214	3/4"	3/4"	7/8"	56.04
JIM-JIM-UNM-141414	7/8"	7/8"	7/8"	45.71
JIM-JIM-UNM-171717	1.1/16"	1.1/16"	1.1/16"	58.59
JIM-JIM-UNM-212121	1.5/16"	1.5/16"	1.5/16"	91.09
JIM-JIM-UNM-262626	1.5/8"	1.5/8"	1.5/8"	192.49

## ADAPTOR - BRANCH TEE

### JIC Male x JIC Male x JIC Female Swivel - Branch Tee

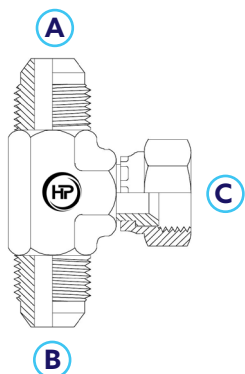

Part Number	A JIC (M)	B JIC (M)	C JIC (FS)	List Price (\$)
JIM-JIM-JIF-070707	7/16"	7/16"	7/16"	25.03
JIM-JIM-JIF-080808	1/2"	1/2"	1/2"	26.46
JIM-JIM-JIF-090909	9/16"	9/16"	9/16"	21.59
JIM-JIM-JIF-121212	3/4"	3/4"	3/4"	27.86
JIM-JIM-JIF-141414	7/8"	7/8"	7/8"	35.94
JIM-JIM-JIF-171717	1.1/16"	1.1/16"	1.1/16"	41.34
JIM-JIM-JIF-212121	1.5/16"	1.5/16"	1.5/16"	59.90
JIM-JIM-JIF-262626	1.5/8"	1.5/8"	1.5/8"	121.75
JIM-JIM-JIF-303030	1.7/8"	1.7/8"	1.7/8"	187.89

## ADAPTOR - BRANCH TEE

### BSPF Female Swivel x BSPF Female Swivel x BSPT Male - Branch Tee

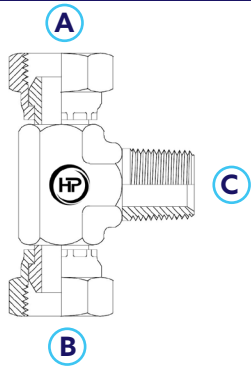

Part Number	A BSPF (FS)	B BSPF (FS)	C BSPT (M)	List Price (\$)
BPF-BPF-BTM-040404	1/4"	1/4"	1/4"	26.97
BPF-BPF-BTM-060606	3/8"	3/8"	3/8"	34.69
BPF-BPF-BTM-080808	1/2"	1/2"	1/2"	41.46
BPF-BPF-BTM-121212	3/4"	3/4"	3/4"	71.04
BPF-BPF-BTM-161616	1"	1"	1"	163.23

## ADAPTOR - BRANCH TEE

### BSPT Male x BSPT Male x BSPF Female Swivel - Branch Tee

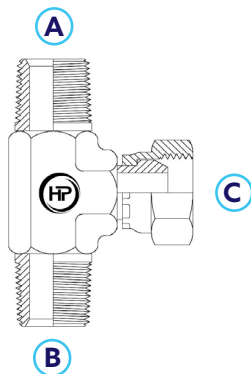

Part Number	A BSPT (M)	B BSPT (M)	C BSPF (FS)	List Price (\$)
BTM-BTM-BSF-040404	1/4"	1/4"	1/4"	36.42
BTM-BTM-BSF-060606	3/8"	3/8"	3/8"	38.67
BTM-BTM-BSF-080808	1/2"	1/2"	1/2"	41.82
BTM-BTM-BSF-121212	3/4"	3/4"	3/4"	53.70
BTM-BTM-BSF-161616	1"	1"	1"	67.42

## ADAPTOR - EQUAL TEE

### JIC Male x JIC Male x JIC Male - Equal Tee

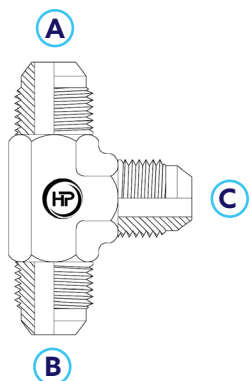

Part Number	A JIC (M)	B JIC (M)	C JIC (M)	List Price (\$)
JIM-JIM-JIM-070707	7/16"	7/16"	7/16"	16.42
JIM-JIM-JIM-080808	1/2"	1/2"	1/2"	26.35
JIM-JIM-JIM-090909	9/16"	9/16"	9/16"	15.00
JIM-JIM-JIM-090912	9/16"	9/16"	3/4"	27.27
JIM-JIM-JIM-121209	3/4"	3/4"	9/16"	23.76
JIM-JIM-JIM-121212	3/4"	3/4"	3/4"	18.38
JIM-JIM-JIM-121214	3/4"	3/4"	7/8"	39.30
JIM-JIM-JIM-121217	3/4"	3/4"	1.1/16"	74.37
JIM-JIM-JIM-141412	7/8"	7/8"	3/4"	26.49
JIM-JIM-JIM-141414	7/8"	7/8"	7/8"	31.24
JIM-JIM-JIM-141417	7/8"	7/8"	1.1/16"	57.41
JIM-JIM-JIM-171714	1.1/16"	1.1/16"	7/8"	60.83
JIM-JIM-JIM-171717	1.1/16"	1.1/16"	1.1/16"	32.55
JIM-JIM-JIM-212117	1.5/16"	1.5/16"	1.1/16"	60.59
JIM-JIM-JIM-212121	1.5/16"	1.5/16"	1.5/16"	54.63
JIM-JIM-JIM-262626	1.5/8"	1.5/8"	1.5/8"	109.57
JIM-JIM-JIM-303030	1.7/8"	1.7/8"	1.7/8"	168.46
JIM-JIM-JIM-404040	2.1/2"	2.1/2"	2.1/2"	327.95

## ADAPTOR - EQUAL TEE

### BSPP Female x BSPP Female x BSPP Female - Equal Tee

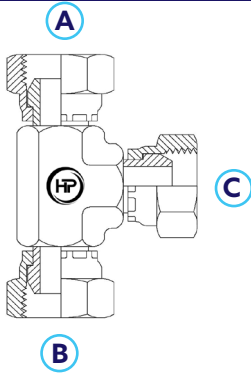

Part Number	A BSPP (F)	B BSPP (F)	C BSPP (F)	List Price (\$)
BSF-BSF-BSF-040404	1/4"	1/4"	1/4"	POA
BSF-BSF-BSF-060606	3/8"	3/8"	3/8"	POA
BSF-BSF-BSF-080808	1/2"	1/2"	1/2"	POA
BSF-BSF-BSF-121212	3/4"	3/4"	3/4"	POA
BSF-BSF-BSF-161616	1"	1"	1"	POA
BSF-BSF-BSF-323232	2"	2"	2"	POA

## ADAPTOR - EQUAL TEE

### BSPT Male x BSPT Male x BSPT Male - Equal Tee

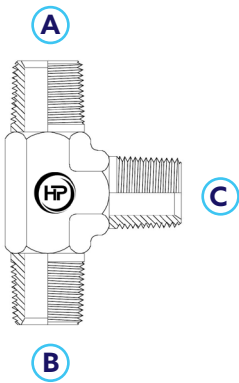

Part Number	A BSPT (M)	B BSPT (M)	C BSPT (M)	List Price (\$)
BTM-BTM-BTM-020202	1/8"	1/8"	1/8"	21.96
BTM-BTM-BTM-040404	1/4"	1/4"	1/4"	19.98
BTM-BTM-BTM-060606	3/8"	3/8"	3/8"	21.76
BTM-BTM-BTM-080808	1/2"	1/2"	1/2"	28.24
BTM-BTM-BTM-080812	1/2"	1/2"	3/4"	53.34
BTM-BTM-BTM-121208	3/4"	3/4"	1/2"	53.41
BTM-BTM-BTM-121212	3/4"	3/4"	3/4"	33.21
BTM-BTM-BTM-161616	1"	1"	1"	52.36
BTM-BTM-BTM-202020	1.1/4"	1.1/4"	1.1/4"	100.72
BTM-BTM-BTM-242424	1.1/2"	1.1/2"	1.1/2"	173.87
BTM-BTM-BTM-323232	2"	2"	2"	394.18

## ADAPTOR - EQUAL TEE

### BSPT Female x BSPT Female x BSPT Female - Equal Tee

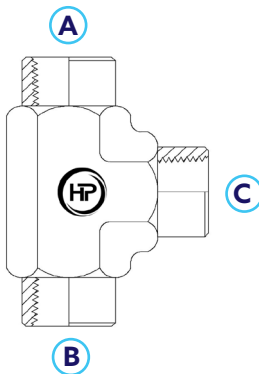

Part Number	A BSPT (F)	B BSPT (F)	C BSPT (F)	List Price (\$)
BTF-BTF-BTF-020202	1/8"	1/8"	1/8"	20.62
BTF-BTF-BTF-040404	1/4"	1/4"	1/4"	17.56
BTF-BTF-BTF-060606	3/8"	3/8"	3/8"	22.64
BTF-BTF-BTF-080808	1/2"	1/2"	1/2"	32.58
BTF-BTF-BTF-121212	3/4"	3/4"	3/4"	45.74
BTF-BTF-BTF-161616	1"	1"	1"	79.19
BTF-BTF-BTF-202020	1.1/4"	1.1/4"	1.1/4"	137.95
BTF-BTF-BTF-242424	1.1/2"	1.1/2"	1.1/2"	202.05
BTF-BTF-BTF-323232	2"	2"	2"	355.19

**JICM X JICM  
STRAIGHT BULKHEAD**

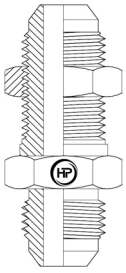

Page 60

**BSPPM X BSPPM  
STRAIGHT BULKHEAD**

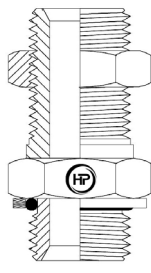

Page 60

**JICM X JICM  
90° BULKHEAD**

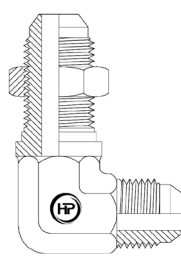

Page 60

**JICM X JICM  
45° BULKHEAD**

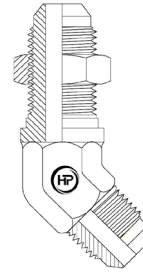

Page 61

**JICF  
NUT & SLEEVE**

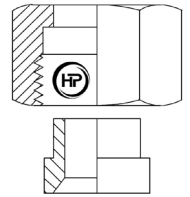

Page 61

**JICM  
PLUG**

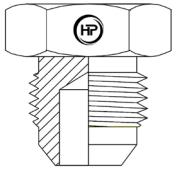

Page 61

**BSPPM  
PLUG**

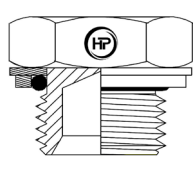

Page 62

**BSPPM  
HEX SOCKET PLUG**

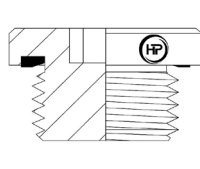

Page 62

**BSPTM  
PLUG**

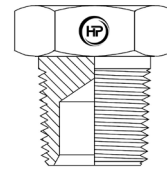

Page 62

**BSPTM  
HEX SOCKET PLUG**

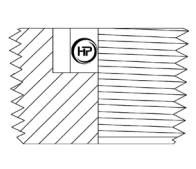

Page 63

**UNOM  
PLUG**

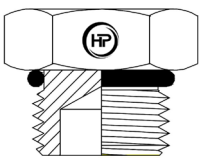

Page 63

**UNOM  
HEX SOCKET PLUG**

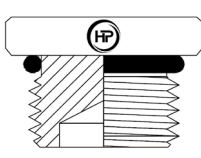

Page 63

**METRICM  
PLUG**

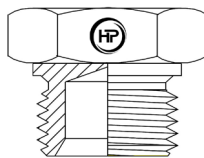

Page 64

*For other sizes and thread types please contact us*

## BULKHEAD - STRAIGHT (M X M)

### JIC Male x JIC Male - Straight BulkHead

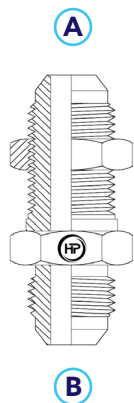

Part Number	A JIC (M)	B JIC (M)	List Price (\$)
JIM-JBM-0707	7/16"	7/16"	14.10
JIM-JBM-0909	9/16"	9/16"	14.32
JIM-JBM-1212	3/4"	3/4"	14.95
JIM-JBM-1414	7/8"	7/8"	17.61
JIM-JBM-1414	1.1/16"	1.1/16"	17.61
JIM-JBM-2121	1.5/16"	1.5/16"	45.76
JIM-JBM-2626	1.5/8"	1.5/8"	66.55
JIM-JBM-3030	1.7/8"	1.7/8"	128.90
JIM-JBM-4040	2.1/2"	2.1/2"	235.53

## BULKHEAD - STRAIGHT (M X M)

### BSPP Male x BSPP Male - Straight BulkHead

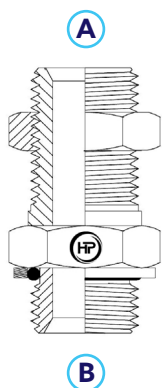

Part Number	A BSPP (M)	B BSPP (M)	List Price (\$)
BPM-BBM-0404	1/4"	1/4"	16.51
BPM-BBM-0606	3/8"	3/8"	22.65
BPM-BBM-0808	1/2"	1/2"	26.54
BPM-BBM-1212	3/4"	3/4"	36.67
BPM-BBM-1616	1"	1"	47.27
BPM-BBM-2020	1.1/4"	1.1/4"	93.70
BPM-BBM-2424	1.1/2"	1.1/2"	163.71

## BULKHEAD - 90° ELBOW (M X M)

### JIC Male x JIC Male - 90° Elbow BulkHead

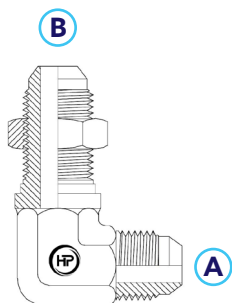

Part Number	A JIC (M)	B JIC (M)	List Price (\$)
JIM-JBM-90C-0707	7/16"	7/16"	24.78
JIM-JBM-90C-0808	1/2"	1/2"	38.64
JIM-JBM-90C-0909	9/16"	9/16"	27.27
JIM-JBM-90C-1212	3/4"	3/4"	32.11
JIM-JBM-90C-1414	7/8"	7/8"	37.98
JIM-JBM-90C-1717	1.1/16"	1.1/16"	49.96
JIM-JBM-90C-2121	1.5/16"	1.5/16"	68.94
JIM-JBM-90C-2626	1.5/8"	1.5/8"	85.54
JIM-JBM-90C-3030	1.7/8"	1.7/8"	153.08

## BULKHEAD - 45° ELBOW (M X M)

### JIC Male x JIC Male - 45° Elbow BulkHead

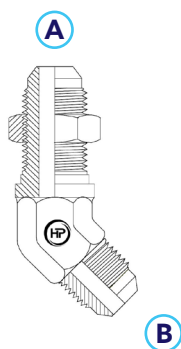

Part Number	A JIC (M)	B JIC (M)	List Price (\$)
JIM-JBM-45C-0707	7/16"	7/16"	20.77
JIM-JBM-45C-0808	1/2"	1/2"	30.38
JIM-JBM-45C-0909	9/16"	9/16"	22.45
JIM-JBM-45C-1212	3/4"	3/4"	24.71
JIM-JBM-45C-1414	7/8"	7/8"	30.41
JIM-JBM-45C-1717	1.1/16"	1.1/16"	41.14
JIM-JBM-45C-2121	1.5/16"	1.5/16"	65.84

## ADAPTOR - NUT & SLEEVE

### JIC Female - Nut & Sleeve

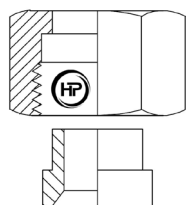

Part Number	JIC (F)	Tube	List Price (\$)
NS-JF07	7/16"	1/4"	6.18
NS-JF08	1/2"	5/16"	7.48
NS-JF09	9/16"	3/8"	6.89
NS-JF12	3/4"	1/2"	8.55
NS-JF14	7/8"	5/8"	11.52
NS-JF17	1.1/16"	3/4"	16.04
NS-JF21	1.5/16"	1"	22.81
NS-JF26	1.5/8"	1.1/4"	41.34
NS-JF30	1.7/8"	1.1/2"	62.13

## ADAPTOR - PLUG

### JIC Male

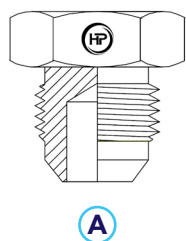

Part Number	A JIC (M)	List Price (\$)
JIM-07	7/16"	4.13
JIM-08	1/2"	5.43
JIM-09	9/16"	4.90
JIM-12	3/4"	4.55
JIM-14	7/8"	5.85
JIM-17	1.1/16"	9.01
JIM-19	1.3/16"	21.50
JIM-21	1.5/16"	23.17
JIM-26	1.5/8"	24.03
JIM-30	1.7/8"	48.91
JIM-40	2.1/2"	130.12

## ADAPTOR - PLUG

### BSPP Male

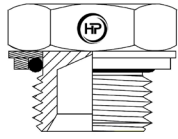

A

Part Number	A BSPP (M)	List Price (\$)
BPM-02	1/8"	10.10
BPM-04	1/4"	7.04
BPM-06	3/8"	8.41
BPM-08	1/2"	5.23
BPM-12	3/4"	10.75
BPM-16	1"	16.30
BPM-20	1.1/4"	32.52
BPM-24	1.1/2"	44.27
BPM-32	2"	87.58

## ADAPTOR - HEX SOCKET PLUG

### BSPP Male

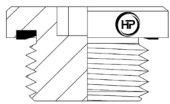

A

Part Number	A BSPP (M)	List Price (\$)
BPM-CS-02	1/8"	6.33
BPM-CS-04	1/4"	7.99
BPM-CS-06	3/8"	6.65
BPM-CS-08	1/2"	9.39

## ADAPTOR - PLUG

### BSPT Male

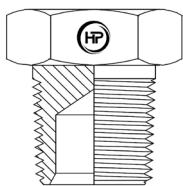

A

Part Number	A BSPT (M)	List Price (\$)
BTM-02	1/8"	4.55
BTM-04	1/4"	4.14
BTM-06	3/8"	3.78
BTM-08	1/2"	4.31
BTM-12	3/4"	7.55
BTM-16	1"	13.66
BTM-20	1.1/4"	19.40
BTM-24	1.1/2"	28.13
BTM-32	2"	59.96



## ADAPTOR - HEX SOCKET PLUG

### BSPT Male

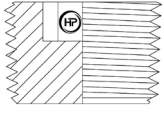

A

Part Number	A BSPT (M)	List Price (\$)
BTM-CS-02	1/8"	6.89
BTM-CS-04	1/4"	5.94
BTM-CS-06	3/8"	4.73
BTM-CS-08	1/2"	5.94
BTM-CS-12	3/4"	11.73
BTM-CS-16	1"	16.97

## ADAPTOR - PLUG

### UNO Male



A

Part Number	A UNO (M)	List Price (\$)
UNM-06	3/8"	5.02
UNM-07	7/16"	5.26
UNM-08	1/2"	6.57
UNM-09	9/16"	4.99
UNM-12	3/4"	5.23
UNM-14	7/8"	6.33
UNM-17	1.1/16"	9.13
UNM-19	1.3/16"	28.22
UNM-21	1.5/16"	22.13
UNM-26	1.5/8"	22.93
UNM-30	1.7/8"	48.77
UNM-40	2.1/2"	82.27

## ADAPTOR - HEX SOCKET PLUG

### UNO Male

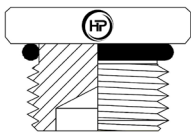

A

Part Number	A UNO (M)	List Price (\$)
UNM-CS-05	5/16"	5.11
UNM-CS-06	3/8"	3.88
UNM-CS-07	7/16"	5.09
UNM-CS-08	1/2"	4.63
UNM-CS-09	9/16"	4.72
UNM-CS-12	3/4"	5.13
UNM-CS-14	7/8"	6.09
UNM-CS-17	1.1/16"	8.28
UNM-CS-21	1.5/16"	13.64
UNM-CS-26	1.5/8"	19.26
UNM-CS-30	1.7/8"	31.91
UNM-CS-40	2.1/2"	47.47

# ADAPTOR - PLUG

## METRIC Male

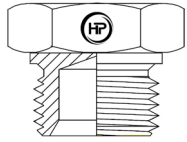

A

Part Number	A METRIC (M)	List Price (\$)
MSM-10	M10 x 1.5	9.50
MSM-12	M12 x 1.5	7.72
MSM-14	M14 x 1.5	8.38
MSM-15	M15 x 1.5	10.81
MSM-16	M16 x 1.5	8.67
MSM-18	M18 x 1.5	10.16
MSM-20	M20 x 1.5	10.16
MSM-22	M22 x 1.5	9.93
MSM-24	M24 x 1.5	16.58
MSM-26	M26 x 1.5	22.45
MSM-27	M27 x 1.5	26.73
MSM-28	M28 x 1.5	23.76
MSM-30	M30 x 2.0	31.03
MSM-33	M33 x 2.0	30.13
MSM-36	M36 x 2.0	46.28
MSM-42	M42 x 2.0	60.59
MSM-52	M52 x 2.0	79.90

**ACCESSORIES**

# CODING SYSTEM

## Quick Release Couplings

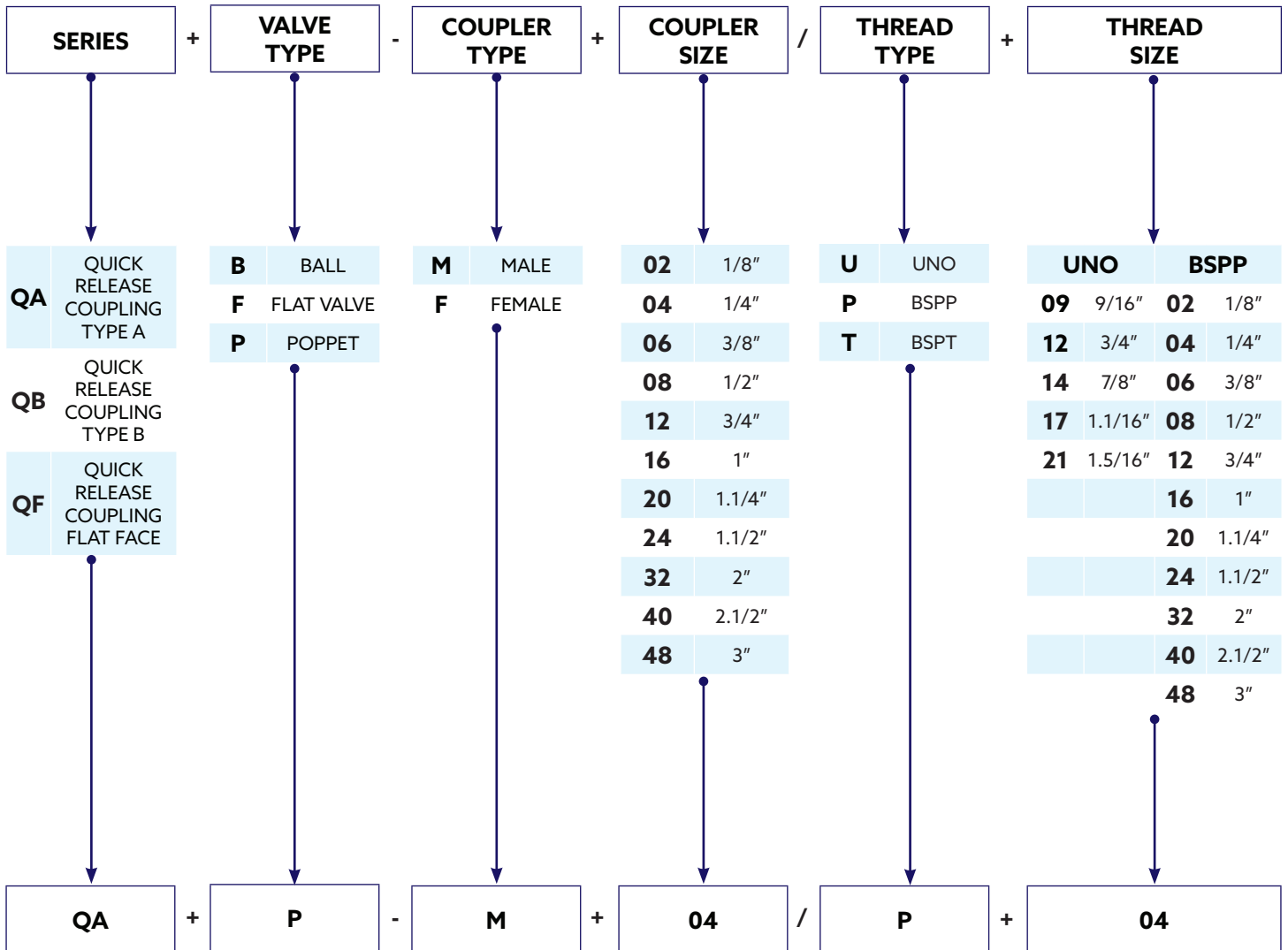

Example  
**QAP-M04/P04**  
 Quick Release Coupler Type A Poppet Valve  
 1/4" BSPP Male Tip

# CODING SYSTEM

## Tube Clamps, Stacking Bolts & Stacking Plates

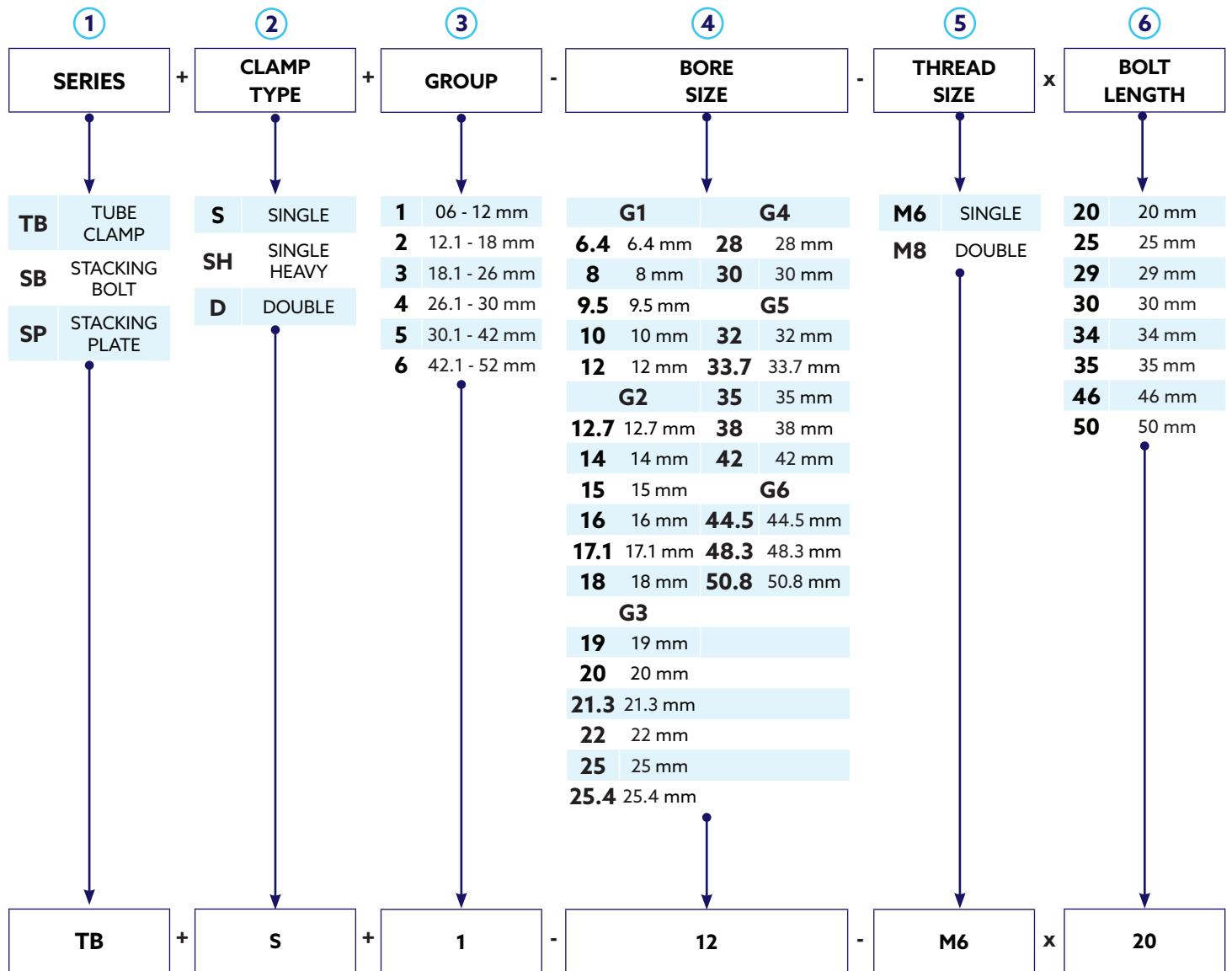

For **TUBE CLAMPS** use 1-4 above

Example (Tube Clamp)  
**TBS1-12**  
 Tube Clamp Single, Group 1  
 12 mm Bore Size

For **STACKING BOLTS** use 1-3, 5-6 above

Example (Stacking Bolt)  
**SBS1-M6x20**  
 Stacking Bolt Single Group 1,  
 Metric 6 - 20 mm long

For **STACKING PLATES** use 1-3 above

Example (Stacking Plate)  
**SPS1**  
 Stacking Plate Single Group 1

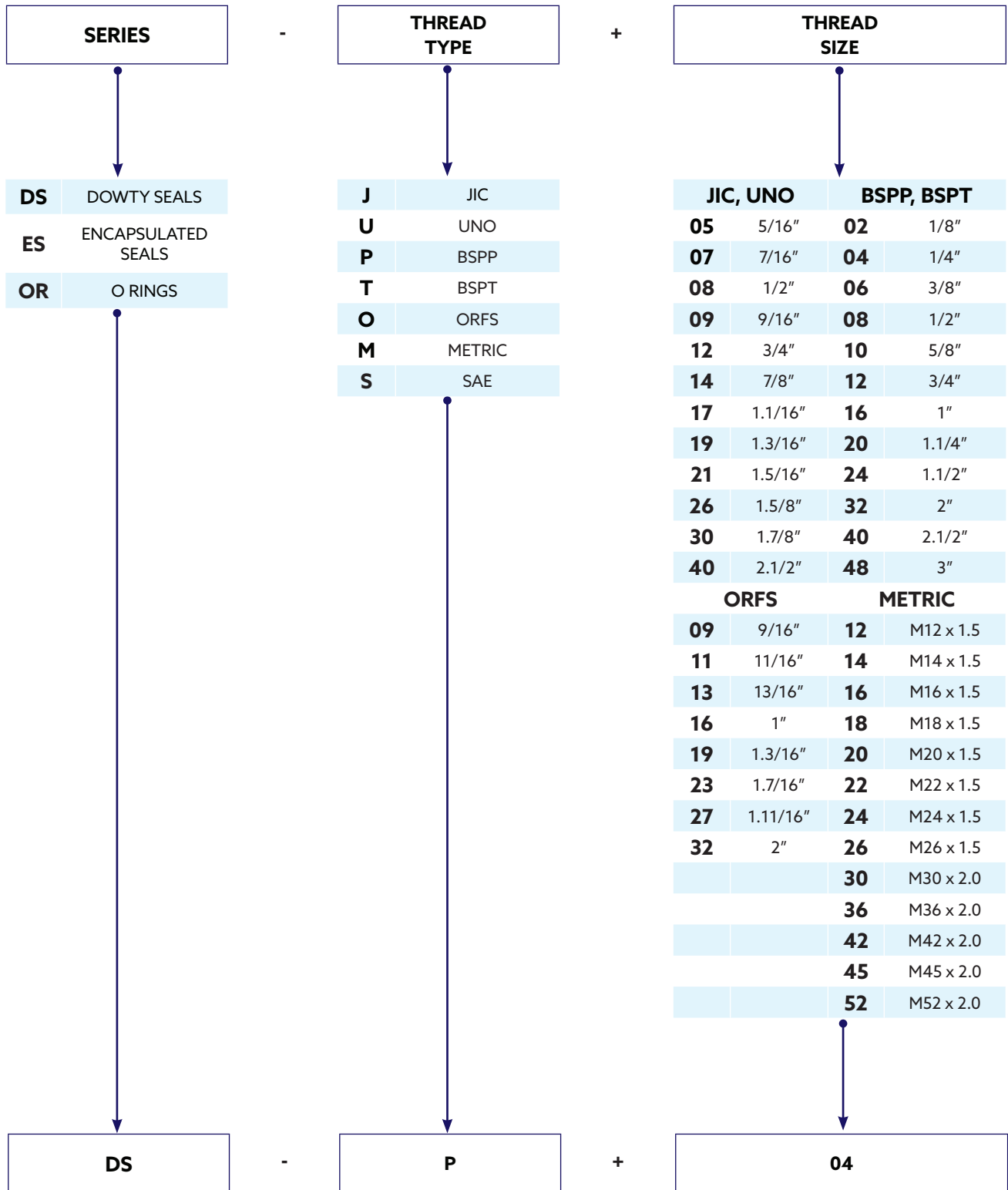

Example  
**DS-P04**  
**BSPP 1/4" Dowty Seal**

**QUICK RELEASE  
COUPLER-TYPE A**

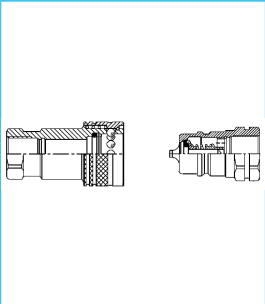

Page 70

**QUICK RELEASE  
COUPLER-FLAT FACE**

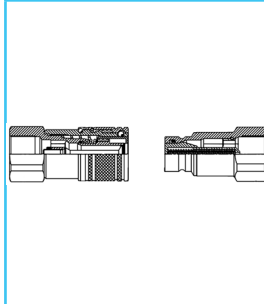

Page 71

**TUBE CLAMP  
SINGLE**

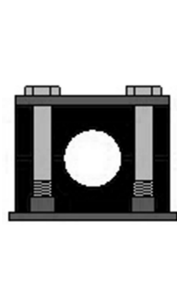

Page 72

**TUBE CLAMP  
SINGLE HEAVY**

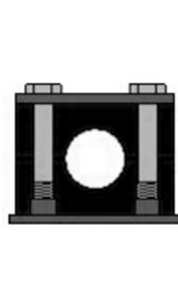

Page 72

**TUBE CLAMP  
DOUBLE**

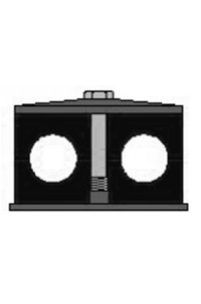

Page 73

**STACKING BOLT  
SINGLE**

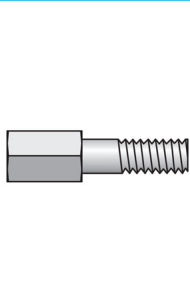

Page 73

**STACKING BOLT  
DOUBLE**

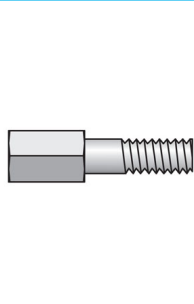

Page 73

**STACKING PLATE  
SINGLE**

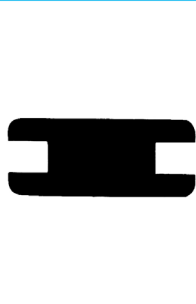

Page 74

**STACKING PLATE  
DOUBLE**

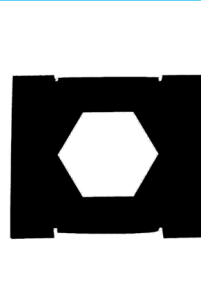

Page 74

**DOWTY SEAL  
METRIC**

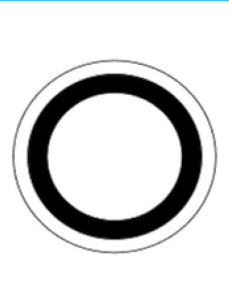

Page 74

**DOWTY SEAL  
BSPP**

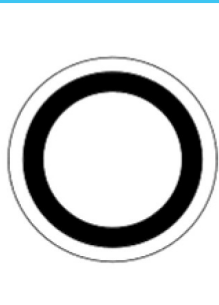

Page 75

**ENCAPSULATED SEAL  
BSPP**

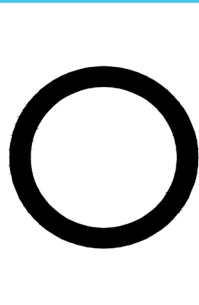

Page 75

**O' RING  
BSPP**

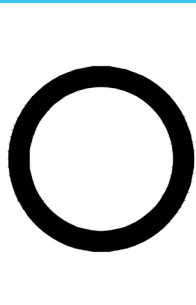

Page 75

**O' RING  
ORFS**

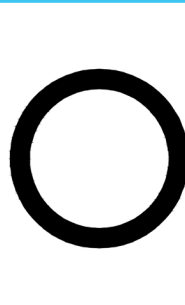

Page 76

**O' RING  
UNO**

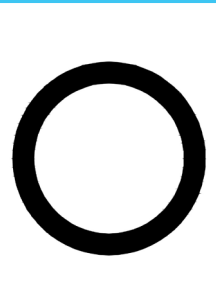

Page 76

**O' RING  
SAE**

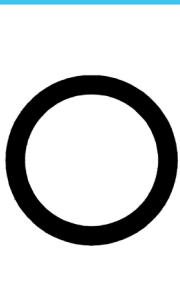

Page 76

*For other sizes and thread types please contact us*

# QUICK RELEASE COUPLING - TYPE A

## Poppet Valve - Male Tip & Coupler

**Series:** ISO 7241-1 Type A

**Valve type:** Poppet

**Material:** Steel

**Interchanges with:** Faster ANV, Parker 6600, DNP PAV, Aeroquip FD56, Safeway S56, Ryco R82

**Applications:** Conforming to ISO 7421-1 Type A used in the Marine and other applications requiring high corrosion resistance.

**Features:** Single acting pull to release sleeve, Poppet type valve for improved sealing.

**Technical:** Seals - Nitrile (Buna N), PTFE backup ring.

**Temperature Range:** 25°C to +125°C.

**Options:** NPT and UNO Threads to Order, Plastic Caps and Plugs, Push-Pull Coupler in 1/2"

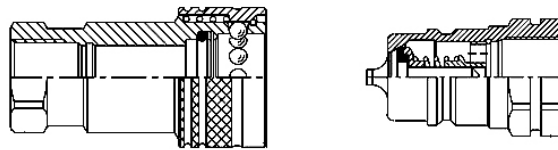

Part Number (Male Tip)	Thread Size	BSPP (F)	WP Bar	List Price (\$)
QAV-04M	1/4"	1/4"	350	17.02
QAV-06M	3/8"	3/8"	300	16.92
QAV-08M	1/2"	1/2"	250	19.42
QAV-12M	3/4"	3/4"	250	39.24
QAV-16M	1"	1"	230	80.99
QAV-20M	1.1/4"	1.1/4"	230	183.15
QAV-24M	1.1/2"	1.1/2"	180	136.68
QAV-32M	2"	2"	130	307.45

Part Number (Coupler)	Thread Size	BSPP (F)	WP Bar	List Price (\$)
QAV-04F	1/4"	1/4"	350	38.59
QAV-06F	3/8"	3/8"	300	38.39
QAV-08F	1/2"	1/2"	250	41.31
QAV-12F	3/4"	3/4"	250	89.87
QAV-16F	1"	1"	230	140.14
QAV-20F	1.1/4"	1.1/4"	230	343.04
QAV-24F	1.1/2"	1.1/2"	180	506.28
QAV-32F	2"	2"	130	934.34



# QUICK RELEASE COUPLING - FLAT FACE

## Flat Valve - Male Tip & Coupler

**Series:** Flat Face

**Valve type:** Flat valve

**Material:** Steel

**Interchanges with:** Faster FFI,Parker FE,DNP PLT4,Safeway S56,Ryco R110.

**Applications:** Conforming to ISO 7421-1 Type B used in general purpose hydraulic applications.

**Features:** Widely used in the public utility markets where oil spillage can constitute a serious hazard.Ease of cleaning is a special feature making these couplers particularly suitable for hostile environments.

**Technical:** Seals - Nitrile (Buna N), PTFE backup ring.

**Temperature Range:** 25°C to +125°C

**Options:** Neoprene,EPDM and Viton seals available. (Available in Stainless Steel).

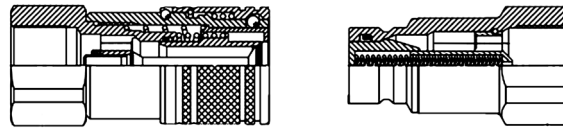

Part Number (Male Tip)	Thread Size	BSPF (F)	WP Bar	List Price (\$)
QFF-04M	1/4"	1/4"	350	77.99
QFF-06M	3/8"	3/8"	250	55.06
QFF-0608M	1/2"	3/8"	250	60.78
QFF-08M	1/2"	1/2"	250	92.13
QFF-0812M	3/4"	1/2"	250	110.06
QFF-12M	3/4"	3/4"	250	154.22
QFF-1216M	1"	3/4"	250	154.22
QFF-16M	1"	1"	210	325.82

Part Number (Coupler)	Thread Size	BSPF (F)	WP Bar	List Price (\$)
QFF-04F	1/4"	1/4"	300	79.01
QFF-06F	3/8"	3/8"	250	92.71
QFF-0608F	1/2"	3/8"	250	98.18
QFF-08F	1/2"	1/2"	250	120.59
QFF-0812F	3/4"	1/2"	250	127.63
QFF-12F	3/4"	3/4"	250	247.34
QFF-1216F	1"	3/4"	250	261.91
QFF-16F	1"	1"	210	485.71

## TUBE CLAMP

### Single

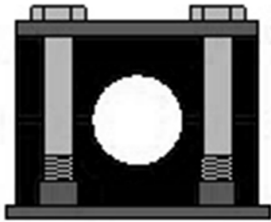

Part Number	Group	Bore Size	List Price (\$)
TCS1-6.4	1	6.4 mm	5.39
TCS1-8	1	8 mm	8.14
TCS1-9.5	1	9.5 mm	5.47
TCS1-10	1	10 mm	5.61
TCS1-12	1	12 mm	5.58
TCS2-12.7	2	12.7 mm	5.17
TCS2-14	2	14 mm	5.75
TCS2-15	2	15 mm	6.13
TCS2-16	2	16 mm	5.75
TCS2-17.1	2	17.1 mm	4.95
TCS2-18	2	18 mm	5.75
TCS3-19	3	19 mm	6.46
TCS3-20	3	20 mm	6.38
TCS3-21.3	3	21.3 mm	5.72
TCS3-22	3	22 mm	6.74
TCS3-25	3	25 mm	5.56
TCS3-25.4	3	25.4 mm	6.33
TCS4-28	4	28 mm	7.07
TCS4-30	4	30 mm	7.07
TCS5-32	5	32 mm	8.83
TCS5-33.7	5	33.7 mm	9.57
TCS5-35	5	35 mm	8.93
TCS5-38	5	38 mm	9.24
TCS5-42	5	42 mm	8.92
TCS6-50.8	6	50.8 mm	13.42

## TUBE CLAMP

### Single Heavy

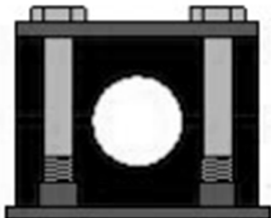

Part Number	Group	Bore Size	List Price (\$)
TCSH2-15	2	15	9.13
TCSH2-16	2	16	11.72
TCSH2-18	2	18	9.13
TCSH3-19	3	19	14.65
TCSH3-20	3	20	11.44
TCSH3-22	3	22	11.44
TCSH4-28	4	28	11.44
TCSH4-30	4	30	11.44
TCSH5-32	5	32	19.73
TCSH5-38	5	38	19.73
TCSH5-42	5	42	18.91
TCSH6-44.5	6	44.5	56.45
TCSH6-48.3	6	48.3	56.45
TCSH6-50.8	6	50.8	43.75

## TUBE CLAMP

### Double

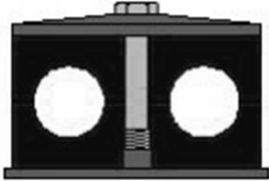

Part Number	Group	Bore Size	List Price (\$)
TCD1-6.4	1	6.4	6.00
TCD1-8	1	8	6.27
TCD1-9.5	1	9.5	5.91
TCD1-10	1	10	6.16
TCD1-12	1	12	6.16
TCD2-12.7	2	12.7	6.62
TCD2-14	2	14	7.15
TCD2-15	2	15	7.15
TCD2-16	2	16	7.15
TCD2-17.1	2	17.1	6.82
TCD2-18	2	18	7.15
TCD3-19	3	19	7.95
TCD3-20	3	20	8.06
TCD3-21.3	3	21.3	8.03
TCD3-22	3	22	8.06
TCD3-25	3	25	6.91
TCD3-25.4	3	25.4	7.99
TCD4-28	4	28	9.35
TCD4-30	4	30	9.35
TCD5-32	5	32	11.53
TCD5-33.7	5	33.7	11.61
TCD5-35	5	35	10.78
TCD5-38	5	38	11.90
TCD5-42	5	42	12.57

## STACKING BOLT

### Single

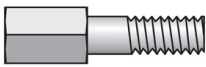

Part Number	Group	Bolt Size	List Price (\$)
SBS1-M6x20	1	20 mm	2.64
SBS2-M6x25	2	25 mm	3.21
SBS3-M6x30	3	30 mm	3.69
SBS4-M6x35	4	35 mm	3.76
SBS5-M6x50	5	50 mm	4.10

## STACKING BOLT

### Double

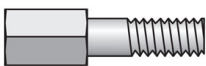

Part Number	Group	Bolt Size	List Price (\$)
SBD1-M6x20	1	20 mm	3.27
SBD2-M8x20	2	20 mm	3.65
SBD3-M8x29	3	29 mm	3.84
SBD4-M8x34	4	34 mm	4.40
SBD5-M8x46	5	46 mm	4.30

## STACKING PLATE

### Single



Part Number	Group	List Price (\$)
SPS1	1	0.33
SPS2	2	1.05
SPS3	3	1.21
SPS4	4	1.40
SPS5	5	1.65

## STACKING PLATE

### Double

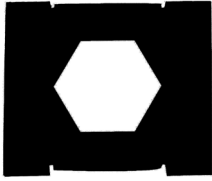

Part Number	Group	List Price (\$)
SPD1	1	1.05
SPD2	2	1.21

## SEAL - DOWTY

### Metric



Part Number	Size	List Price (\$)
DS-M08	8 mm	3.19
DS-M10	10 mm	2.15
DS-M12	12 mm	1.85
DS-M14	14 mm	2.04
DS-M16	16 mm	2.13
DS-M18	18 mm	2.60
DS-M20	20 mm	2.22
DS-M22	22 mm	2.54
DS-M24	24 mm	2.68
DS-M26	26 mm	3.11
DS-M27	27 mm	3.62
DS-M30	30 mm	4.13
DS-M33	33 mm	5.19
DS-M36	36 mm	5.61
DS-M42	42 mm	8.44
DS-M45	45 mm	8.25
DS-M48	48 mm	11.62
DS-M52	52 mm	9.90

## SEAL - DOWTY

BSPB

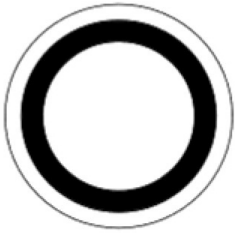

Part Number	Size (BSPB)	List Price (\$)
DS-P02	1/8"	1.72
DS-P04	1/4"	1.90
DS-P06	3/8"	2.05
DS-P08	1/2"	2.23
DS-P10	5/8"	2.31
DS-P12	3/4"	2.85
DS-P16	1"	3.85
DS-P20	1.1/4"	6.82
DS-P24	1.1/2"	8.11
DS-P32	2"	12.55
DS-P40	2.1/2"	66.97

## SEAL - ENCAPSULATED

BSPB

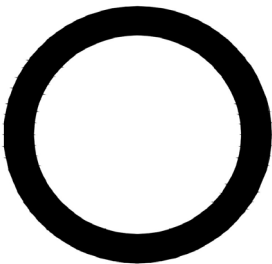

Part Number	Size	List Price (\$)
ES-P04	1/4"	0.72
ES-P06	3/8"	0.69
ES-P08	1/2"	0.81
ES-P12	3/4"	0.89
ES-P16	1"	1.49
ES-P20	1.1/4"	2.20

## RING - O'

BSPB

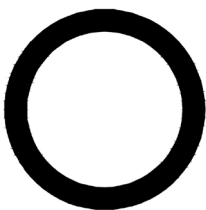

Part Number	Size	List Price (\$)
OR-P02	1/8"	1.35
OR-P04	1/4"	1.51
OR-P06	3/8"	1.56
OR-P08	1/2"	1.40
OR-P10	5/8"	1.45
OR-P12	3/4"	1.56
OR-P16	1"	1.73
OR-P20	1.1/4"	2.41
OR-P24	1.1/2"	4.15
OR-P32	2"	7.95

## RING - O'

### ORFS

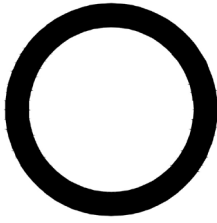

Part Number	Size	List Price (\$)
OR-O09	9/16"	0.75
OR-O11	11/16"	0.79
OR-O13	13/16"	0.98
OR-O16	1"	1.14
OR-O19	1.3/16"	1.49
OR-O23	1.7/16"	1.74
OR-O27	1.11/16"	2.24
OR-O32	2"	2.75

## RING - O'

### UNO

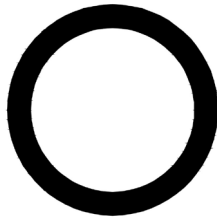

Part Number	Size	List Price (\$)
OR-U07	7/16"	0.98
OR-U08	1/2"	1.01
OR-U09	9/16"	1.01
OR-U12	3/4"	1.38
OR-U14	7/8"	1.38
OR-U17	1.1/16"	1.38
OR-U21	1.5/16"	1.71
OR-U26	1.5/8"	2.48
OR-U30	1.7/8"	2.81
OR-U40	2.1/2"	4.16

## RING - O'

### SAE

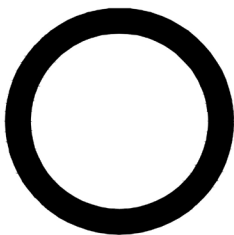

Part Number	Size	List Price (\$)
OR-S08	1/2"	1.55
OR-S12	3/4"	1.73
OR-S14	7/8"	2.42
OR-S16	1"	2.26
OR-S20	1.1/4"	2.48
OR-S24	1.1/2"	3.26
OR-S32	2"	3.87
OR-S40	2.1/2"	5.08

**FULL RANGE**

# PICTURE INDEX - HOSE ENDS FULL RANGE

## Crimp Fittings - One Piece & Two Piece

JIC FEMALE SWIVEL  
STRAIGHT

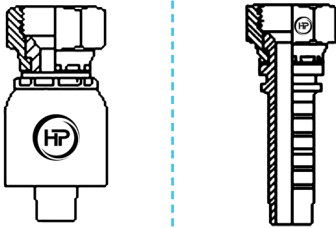

Page 16

JIC MALE  
STRAIGHT

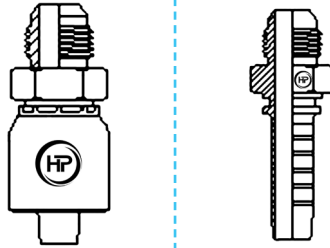

Page 18

JIC FEMALE SWIVEL  
90° COMPACT

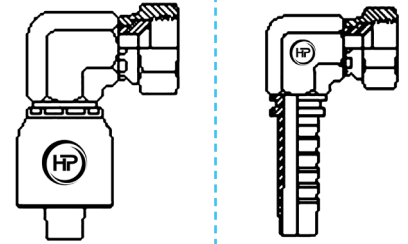

Page 16

JIC FEMALE SWIVEL  
90° SWEPT

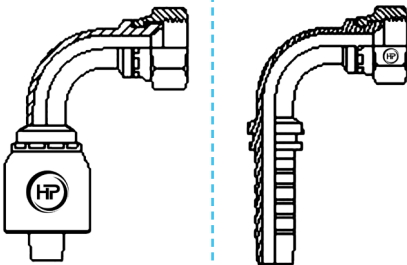

Page 17

JIC FEMALE SWIVEL  
90° LONG DROP

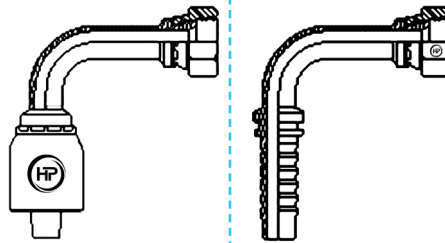

Page 17

JIC FEMALE SWIVEL  
45° SWEPT

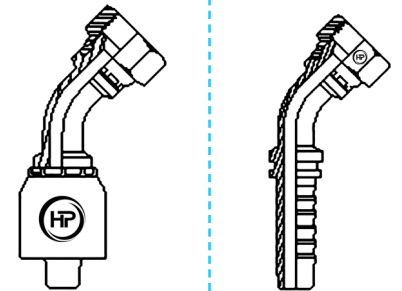

Page 18

BSPF FEMALE SWIVEL  
STRAIGHT

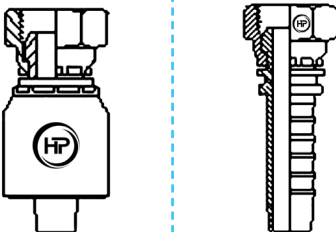

Page 20

BSPF MALE  
STRAIGHT

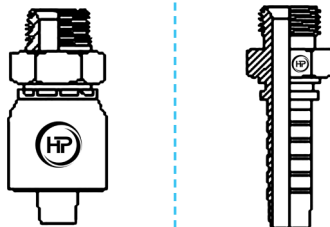

Page 20

BSPT MALE  
STRAIGHT

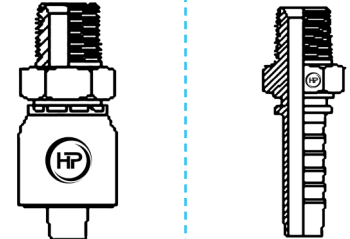

Page 21

BSPF FEMALE SWIVEL  
90° COMPACT

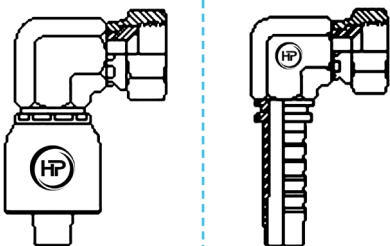

Page 21

BSPF FEMALE SWIVEL  
90° SWEPT

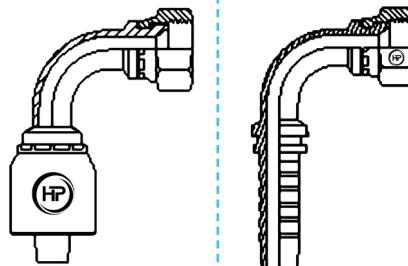

Page 22

BSPF FEMALE SWIVEL  
45° SWEPT

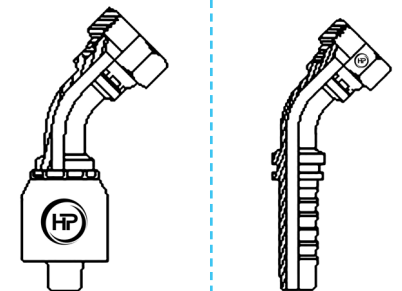

Page 22

For POA please contact us

Continued on the following page...



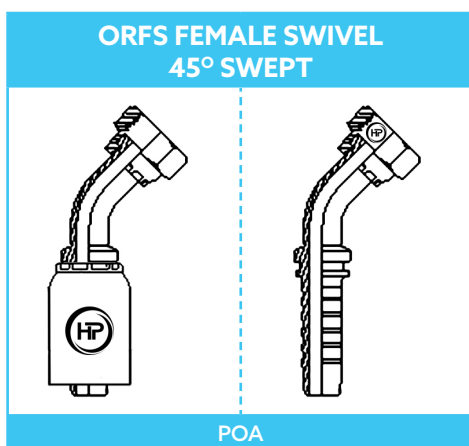
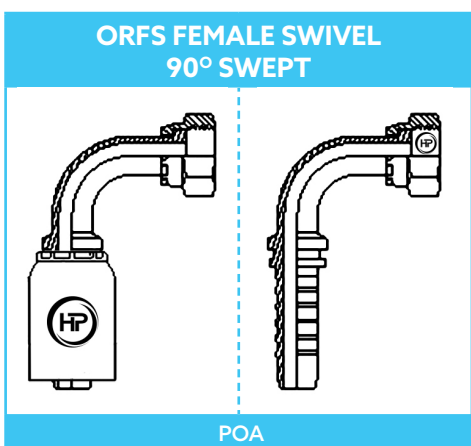
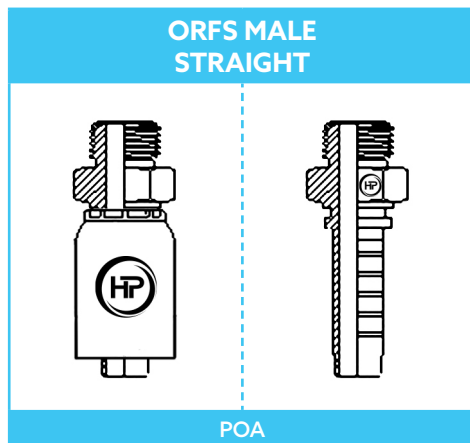
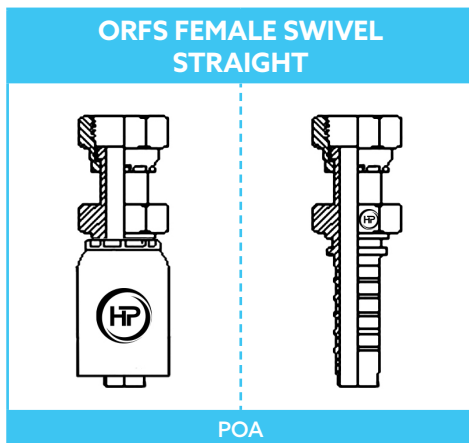
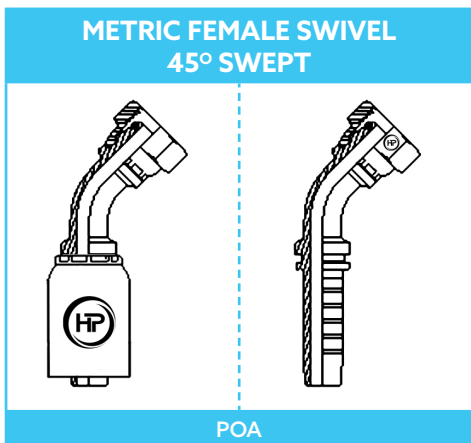
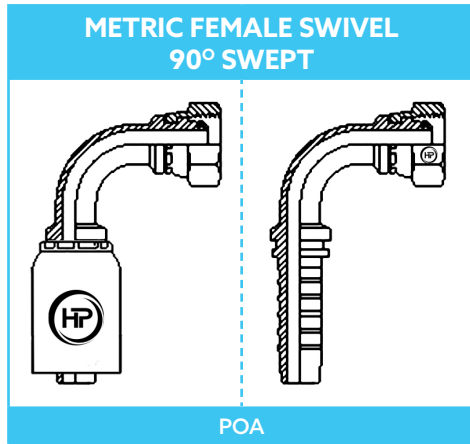
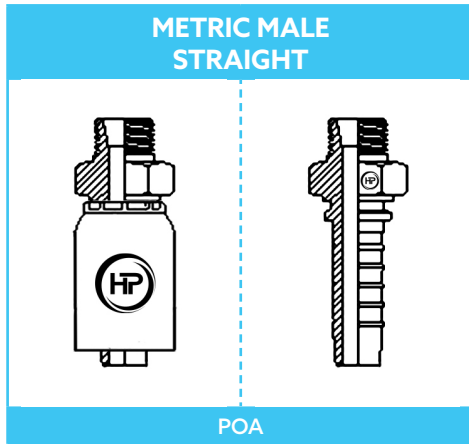
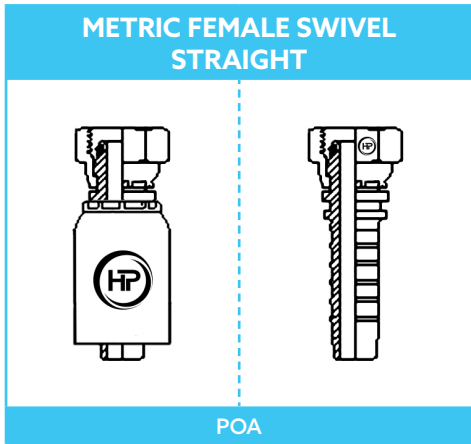
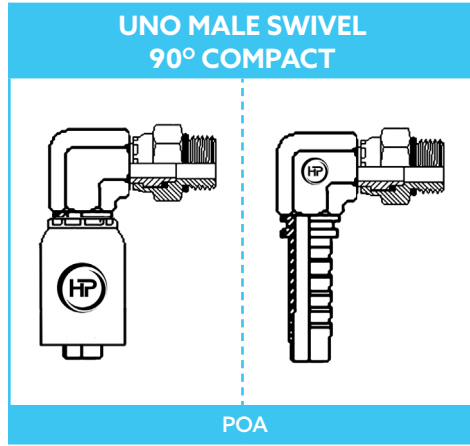
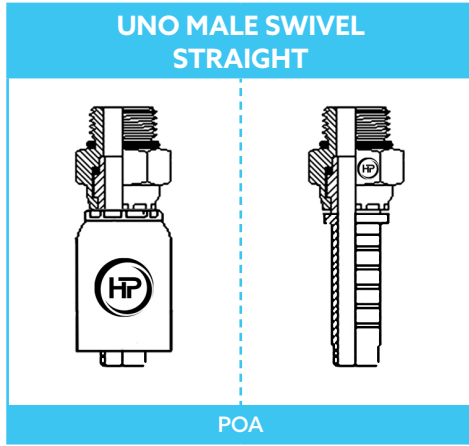
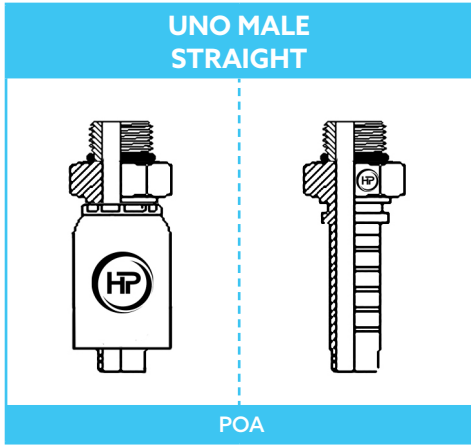

For POA please contact us

Continued on the following page...

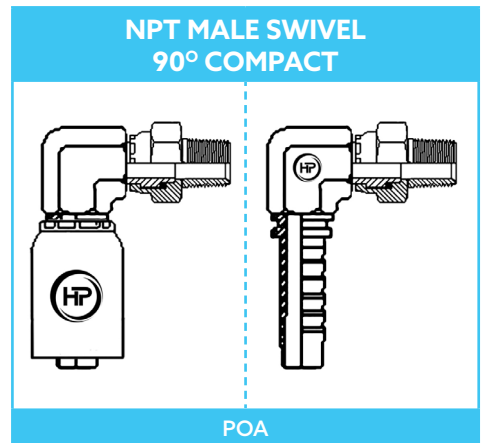
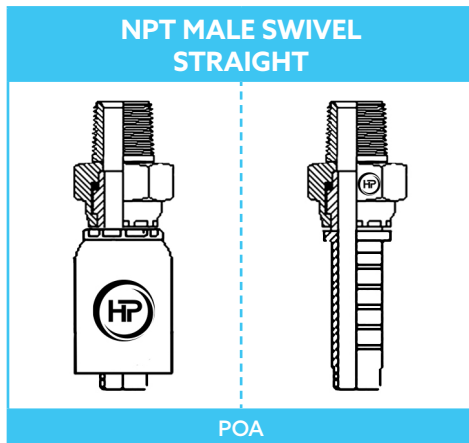
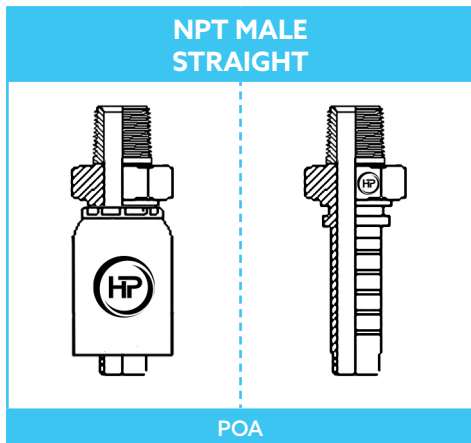
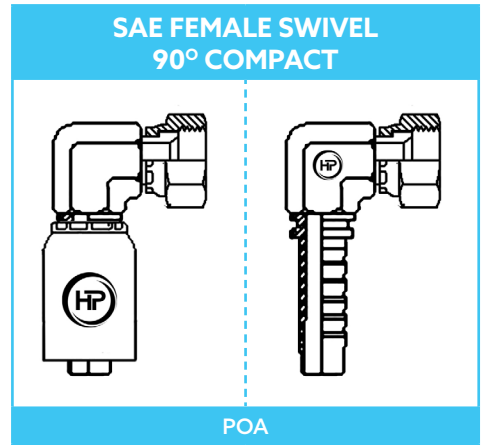
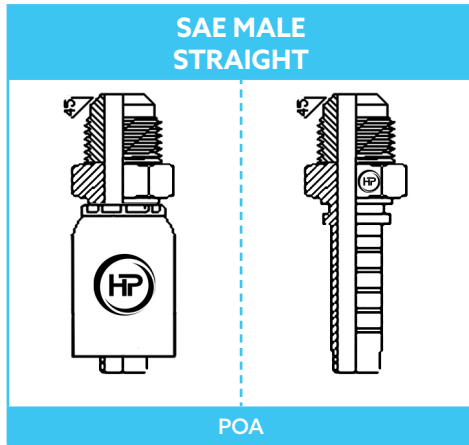
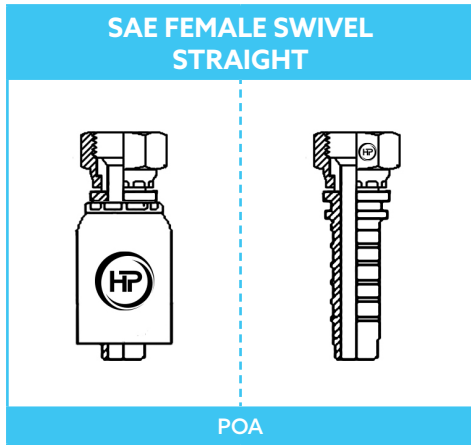

**Suction Fittings**

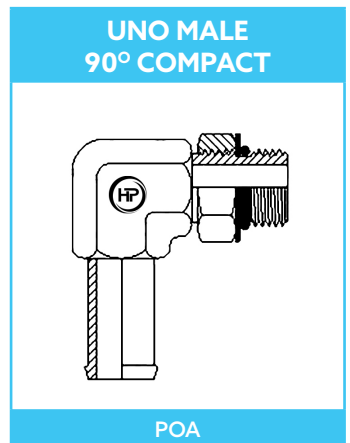
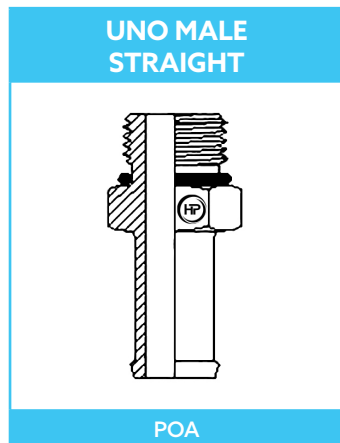
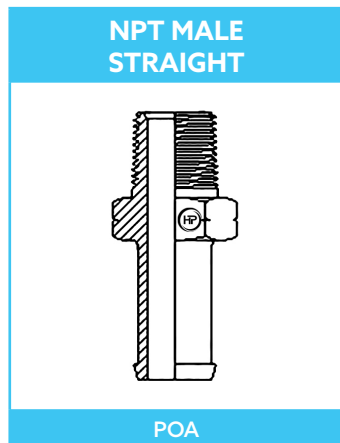
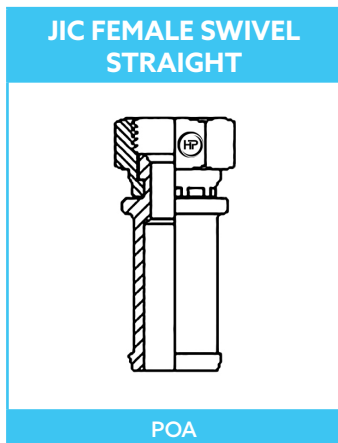
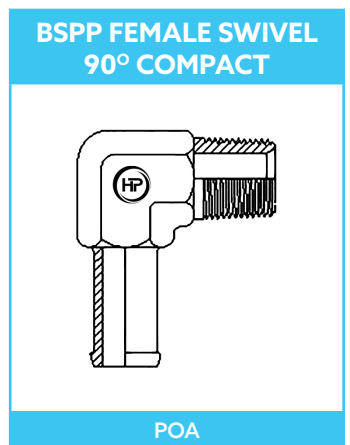
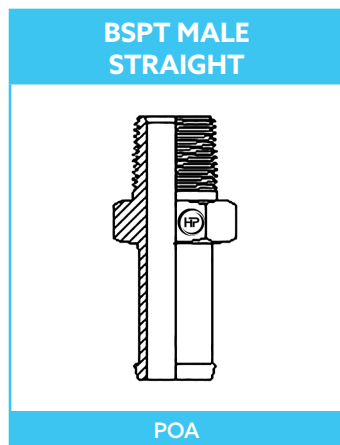
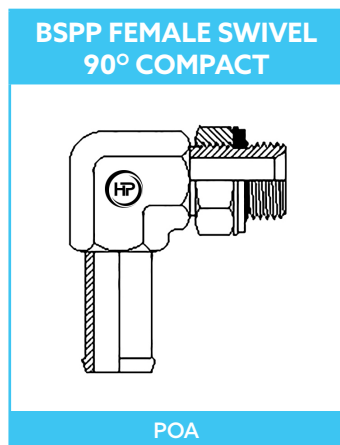
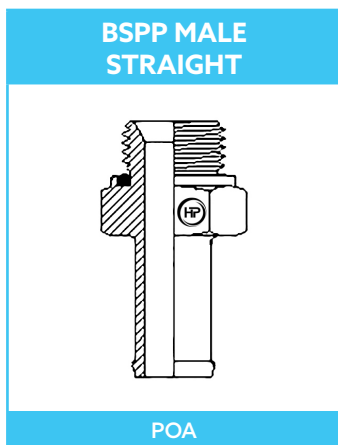

*For POA please contact us*

# Reusable Fittings

**BSPP FEMALE SWIVEL STRAIGHT**

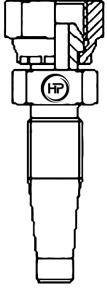

POA

**BSPT MALE STRAIGHT**

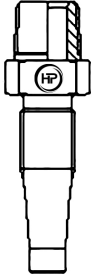

POA

**BSPP MALE 90° COMPACT**

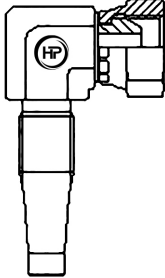

POA

**BSPP FEMALE SWIVEL 90° SWEPT**

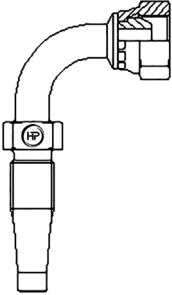

POA

**BSPP FEMALE SWIVEL 45° SWEPT**

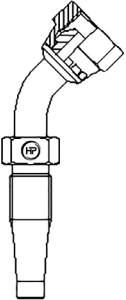

POA

**JIC FEMALE SWIVEL STRAIGHT**

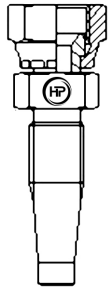

POA

**JIC MALE STRAIGHT**

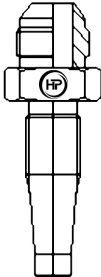

POA

**JIC FEMALE SWIVEL 90° COMPACT**

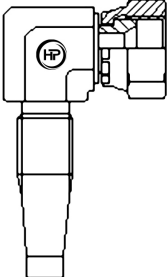

POA

**JIC FEMALE SWIVEL 90° SWEPT**

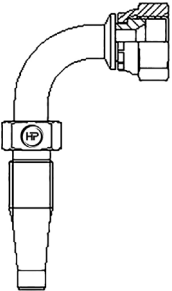

POA

**JIC FEMALE SWIVEL 45° SWEPT**

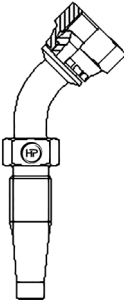

POA

**ORFS FEMALE SWIVEL STRAIGHT**

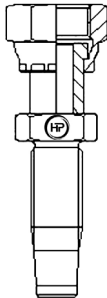

POA

**ORFS FEMALE SWIVEL 90° SWEPT**

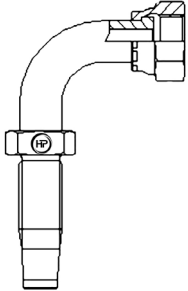

POA

**ONE WIRE FERRULE**

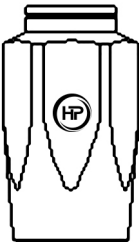

POA

**TWO WIRE FERRULE**

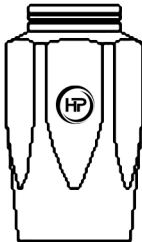

POA

*For POA please contact us*

# PICTURE INDEX - ADAPTORS FULL RANGE

## Straight M x M, M x F & F x F

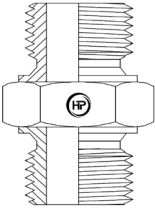
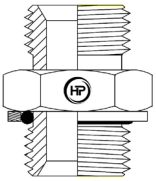
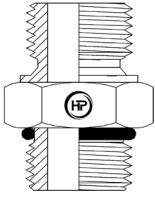
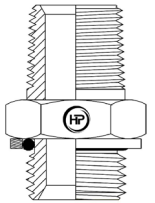
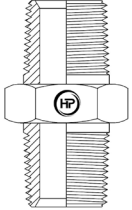
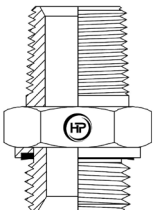
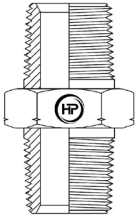
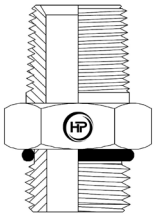
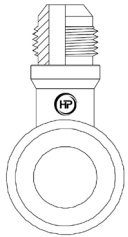
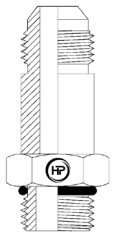
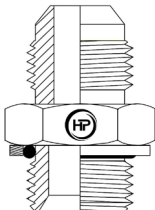
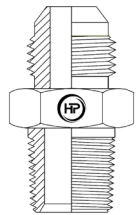
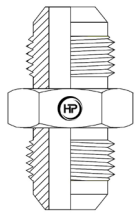
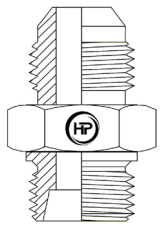
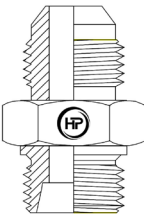
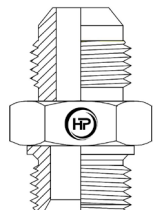
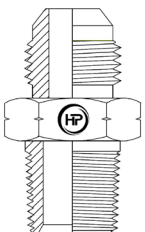
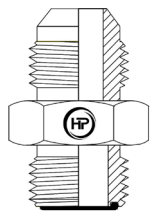
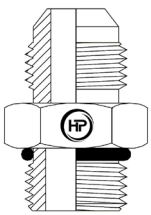
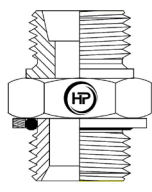
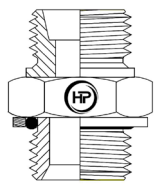
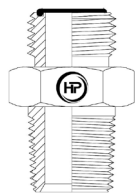
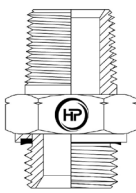
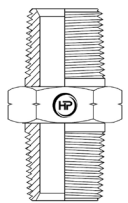
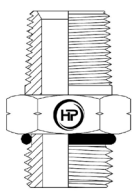
<p><b>BSPPM X BSPPM (DS)</b> STRAIGHT (M X M)</p>  <p>Page 29</p>	<p><b>BSPPM X BSPPM</b> STRAIGHT (M X M)</p>  <p>POA</p>	<p><b>BSPPM X UNOM</b> STRAIGHT (M X M)</p>  <p>POA</p>	<p><b>BSPTM X BSPPM</b> STRAIGHT (M X M)</p>  <p>Page 30</p>	<p><b>BSPTM X BSPTM</b> STRAIGHT (M X M)</p>  <p>Page 30</p>
<p><b>BSPTM X METRICM</b> STRAIGHT (M X M)</p>  <p>POA</p>	<p><b>BSPTM X NPTM</b> STRAIGHT (M X M)</p>  <p>POA</p>	<p><b>BSPTM X UNOM</b> STRAIGHT (M X M)</p>  <p>Page 31</p>	<p><b>JICM BANJO</b> STRAIGHT (M X M)</p>  <p>POA</p>	<p><b>JICM EXT X UNOM</b> STRAIGHT (M X M)</p>  <p>POA</p>
<p><b>JICM X BSPPM</b> STRAIGHT (M X M)</p>  <p>Page 26</p>	<p><b>JICM X BSPTM</b> STRAIGHT (M X M)</p>  <p>Page 27</p>	<p><b>JICM X JICM</b> STRAIGHT (M X M)</p>  <p>Page 29</p>	<p><b>JICM X METRICM(DKL)</b> STRAIGHT (M X M)</p>  <p>POA</p>	<p><b>JICM X METRICM(DKS)</b> STRAIGHT (M X M)</p>  <p>POA</p>
<p><b>JICM X METRICM</b> STRAIGHT (M X M)</p>  <p>POA</p>	<p><b>JICM X NPTM</b> STRAIGHT (M X M)</p>  <p>POA</p>	<p><b>JICM X ORFSM</b> STRAIGHT (M X M)</p>  <p>POA</p>	<p><b>JICM X UNOM</b> STRAIGHT (M X M)</p>  <p>28</p>	<p><b>METRICM(DKL) X BSPTM</b> STRAIGHT (M X M)</p>  <p>POA</p>
<p><b>METRICM(DKS) X BSPTM</b> STRAIGHT (M X M)</p>  <p>POA</p>	<p><b>METRICM(FF) X BSPTM</b> STRAIGHT (M X M)</p>  <p>POA</p>	<p><b>NPTM X BSPPM</b> STRAIGHT (M X M)</p>  <p>POA</p>	<p><b>NPTM X NPTM</b> STRAIGHT (M X M)</p>  <p>POA</p>	<p><b>NPTM X UNOM</b> STRAIGHT (M X M)</p>  <p>POA</p>

For POA please contact us

Continued on the following page...

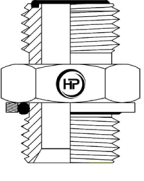
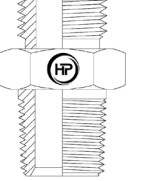
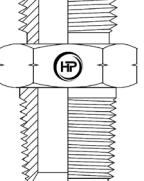
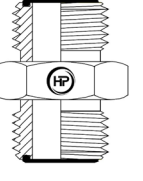
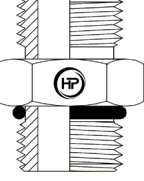
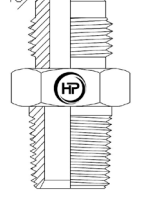
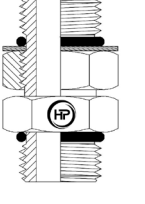
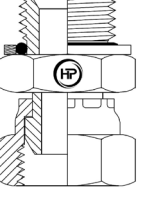
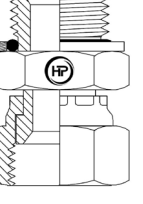
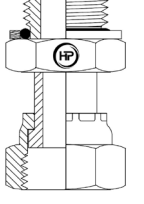
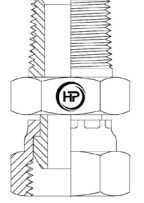
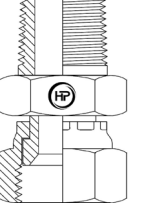
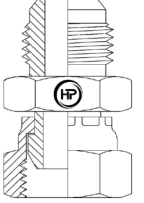
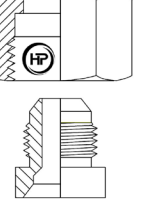
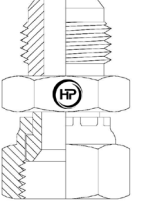
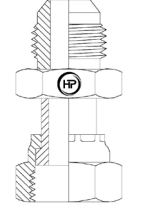
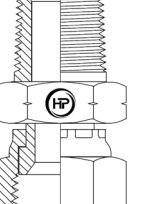
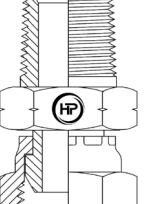
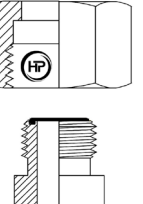
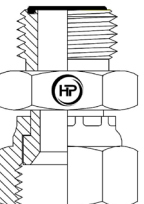
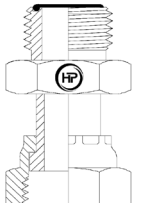
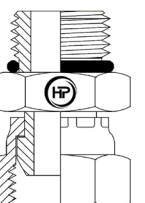
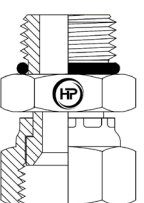
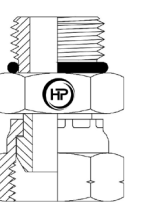
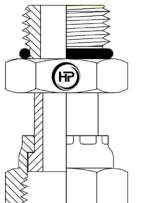
<p><b>ORFSM X BSPPM</b> STRAIGHT (M X M)</p>  <p>POA</p>	<p><b>ORFSM X BSPTM</b> STRAIGHT (M X M)</p>  <p>POA</p>	<p><b>ORFSM X NPTM</b> STRAIGHT (M X M)</p>  <p>POA</p>	<p><b>ORFSM X ORFSM</b> STRAIGHT (M X M)</p>  <p>POA</p>	<p><b>ORFSM X UNOM</b> STRAIGHT (M X M)</p>  <p>POA</p>
<p><b>SAEM(45°) X BSPTM</b> STRAIGHT (M X M)</p>  <p>POA</p>	<p><b>UNOM X UNOM</b> STRAIGHT (M X M)</p>  <p>POA</p>	<p><b>BSPPM X BSPPF</b> STRAIGHT (M X FS)</p>  <p>Page 34</p>	<p><b>BSPPM X JICF</b> STRAIGHT (M X FS)</p>  <p>Page 32</p>	<p><b>BSPPM X ORFSF</b> STRAIGHT (M X FS)</p>  <p>POA</p>
<p><b>BSPTM X BSPPF</b> STRAIGHT (M X FS)</p>  <p>Page 34</p>	<p><b>BSPTM X JICF</b> STRAIGHT (M X FS)</p>  <p>Page 32</p>	<p><b>JICM X BSPPF</b> STRAIGHT (M X FS)</p>  <p>POA</p>	<p><b>JICM X JICF (TR)</b> STRAIGHT (M X FS)</p>  <p>Page 34</p>	<p><b>JICM X JICF</b> STRAIGHT (M X FS)</p>  <p>Page 33</p>
<p><b>JICM X ORFSF</b> STRAIGHT (M X FS)</p>  <p>POA</p>	<p><b>NPTM X JICF</b> STRAIGHT (M X FS)</p>  <p>POA</p>	<p><b>NPTM X NPTF</b> STRAIGHT (M X FS)</p>  <p>POA</p>	<p><b>ORFSM X ORFSF (TR)</b> STRAIGHT (M X FS)</p>  <p>POA</p>	<p><b>ORFSM X JICF</b> STRAIGHT (M X FS)</p>  <p>POA</p>
<p><b>ORFSM X ORFSF</b> STRAIGHT (M X FS)</p>  <p>POA</p>	<p><b>UNOM X BSPPF</b> STRAIGHT (M X FS)</p>  <p>Page 35</p>	<p><b>UNOM X JICF</b> STRAIGHT (M X FS)</p>  <p>Page 33</p>	<p><b>UNOM X NPSMF</b> STRAIGHT (M X FS)</p>  <p>POA</p>	<p><b>UNOM X ORFSF</b> STRAIGHT (M X FS)</p>  <p>POA</p>

For POA please contact us

Continued on the following page...

**BSPPM X BSPPF**  
STRAIGHT (M X FF)

Page 34

**BSPTM X BSPTF**  
STRAIGHT (M X FF)

POA

**BSPTM X NPTF**  
STRAIGHT (M X FF)

POA

**BSPTM X UNOF**  
STRAIGHT (M X FF)

POA

**JICM X BSPTF**  
STRAIGHT (M X FF)

POA

**JICM X JICF (TE)**  
STRAIGHT (M X FF)

POA

**JICM X NPTF**  
STRAIGHT (M X FF)

POA

**NPTM X NPTF**  
STRAIGHT (M X FF)

POA

**NPTM X UNOF**  
STRAIGHT (M X FF)

POA

**ORFSM X ORFSF**  
STRAIGHT (M X FF)

POA

**ORFSM X UNOF**  
STRAIGHT (M X FF)

POA

**UNOM X BSPTF**  
STRAIGHT (M X FF)

POA

**UNOM X NPTF**  
STRAIGHT (M X FF)

POA

**UNOM X UNOF**  
STRAIGHT (M X FF)

POA

**BSPPF X BSPPF**  
STRAIGHT (FS X FS)

POA

**JICF X JICF**  
STRAIGHT (FS X FS)

POA

**BSPTF X BSPPF**  
STRAIGHT (FF X FS)

Page 35

**NPTF X JICF**  
STRAIGHT (FF X FS)

POA

**BSPTF X BSPTF**  
STRAIGHT (FF X FF)

Page 34

**NPTF X NPTF**  
STRAIGHT (FF X FF)

POA

**BSPPF X BSPPF**  
STRAIGHT (FF X FF)

Page 36

**UNOF X UNOF**  
STRAIGHT (FF X FF)

Page 36

*For POA please contact us*

# 90 Degree - M x M, M x F & F x F

<p><b>BSPPM X BSPPM(ADJ.)</b> 90° ELBOW (M X M)</p> <p>Page 41</p>	<p><b>BSPTM X BSPPM</b> 90° ELBOW (M X M)</p> <p>Page 41</p>	<p><b>BSPTM X BSPTM</b> 90° ELBOW (M X M)</p> <p>Page 41</p>	<p><b>BSPTM X BSPTM</b> 90° ELBOW (M X MS)</p> <p>POA</p>	<p><b>BSPTM X UNOM</b> 90° ELBOW (M X M)</p> <p>Page 42</p>
<p><b>JICM X BSPPM</b> 90° ELBOW (M X M)</p> <p>Page 38</p>	<p><b>JICM X BSPPM(EXT.)</b> 90° ELBOW (M X M)</p> <p>POA</p>	<p><b>JICM X BSPTM</b> 90° ELBOW (M X M)</p> <p>Page 38</p>	<p><b>JICM X BSPTM</b> 90° ELBOW (M X MS)</p> <p>POA</p>	<p><b>JICM X BSPTM(EXT.)</b> 90° ELBOW (M X M)</p> <p>POA</p>
<p><b>JICM X JICM</b> 90° ELBOW (M X M)</p> <p>Page 40</p>	<p><b>JICM X NPTM</b> 90° ELBOW (M X M)</p> <p>POA</p>	<p><b>JICM X NPTM(EXT.)</b> 90° ELBOW (M X M)</p> <p>POA</p>	<p><b>JICM X UNOM</b> 90° ELBOW (M X M)</p> <p>Page 39</p>	<p><b>JICM X UNOM</b> 90° ELBOW (M X MS)</p> <p>POA</p>
<p><b>JICM X UNOM(EXT.)</b> 90° ELBOW (M X M)</p> <p>Page 40</p>	<p><b>METRICM(DKL) X BSPTM</b> 90° ELBOW (M X M)</p> <p>POA</p>	<p><b>NPTM X NPTM</b> 90° ELBOW (M X M)</p> <p>POA</p>	<p><b>NPTM X UNOM</b> 90° ELBOW (M X M)</p> <p>POA</p>	<p><b>ORFSM X BSPPM</b> 90° ELBOW (M X M)</p> <p>POA</p>
<p><b>ORFSM X NPTM</b> 90° ELBOW (M X M)</p> <p>POA</p>	<p><b>ORFSM X ORFSM</b> 90° ELBOW (M X M)</p> <p>POA</p>	<p><b>ORFSM X UNOM</b> 90° ELBOW (M X M)</p> <p>POA</p>	<p><b>SAEM(45°) X BSPTM</b> 90° ELBOW (M X M)</p> <p>POA</p>	<p><b>UNOM X UNOM</b> 90° ELBOW (M X M)</p> <p>POA</p>

For POA please contact us

Continued on the following page...

**BSPPM(ADJ.) X JICF**  
90° ELBOW (M X FS)

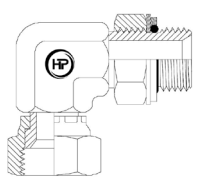

POA

**BSPPM X BSPPF**  
90° ELBOW (M X FS)

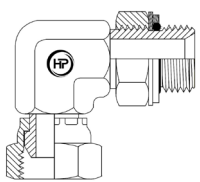

Page 44

**BSPTM X BSPPF**  
90° ELBOW (M X FS)

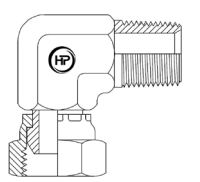

Page 44

**BSPTM X JICF**  
90° ELBOW (M X FS)

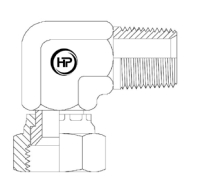

POA

**JICM X JICF**  
90° ELBOW (M X FS)

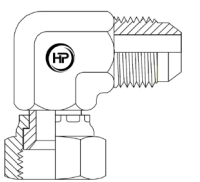

Page 43

**JICM X JICF**  
90° BEND (M X FS)

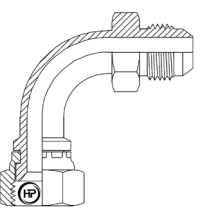

Page 43

**JICM X JICF**  
90° LONG BEND (M X FS)

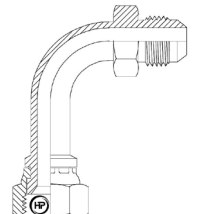

Page 43

**NPTM X NPTF**  
90° ELBOW (M X FS)

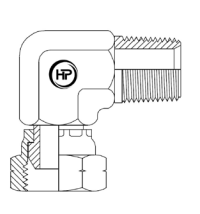

POA

**ORFSM X ORFSF**  
90° ELBOW (M X FS)

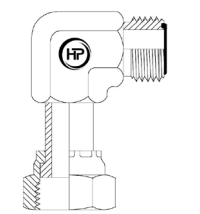

POA

**SAEM X SAEF (45°)**  
90° ELBOW (M X FS)

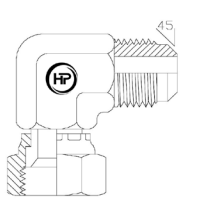

POA

**UNOM X BSPPF**  
90° ELBOW (M X FS)

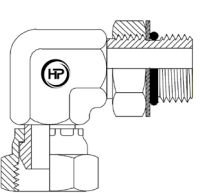

Page 44

**UNOM X JICF**  
90° ELBOW (M X FS)

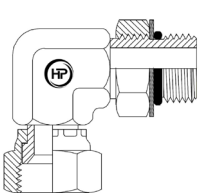

Page 42

**UNOM X ORFSF**  
90° ELBOW (M X FS)

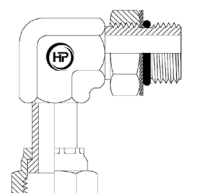

POA

**BSPTM X BSPTF**  
90° ELBOW (M X FF)

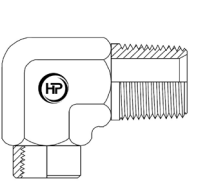

Page 45

**JICM X BSPTF**  
90° ELBOW (M X FF)

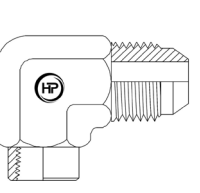

POA

**JICM X NPTF**  
90° ELBOW (M X FF)

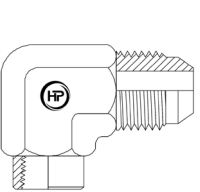

POA

**NPTM X NPTF**  
90° ELBOW (M X FF)

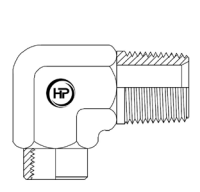

POA

**UNOM X UNOF**  
90° ELBOW (M X FF)

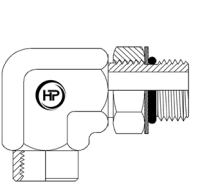

POA

**BSPTF X BSPTF**  
90° ELBOW (FF X FF)

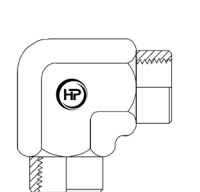

Page 45

**NPTF X NPTF**  
90° ELBOW (FF X FF)

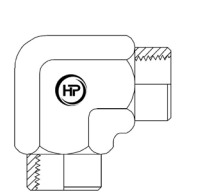

POA

45 Degree - M x M, M x F & F x F

**BSPPM X BSPPM(ADJ.)**  
45° ELBOW (M X M)

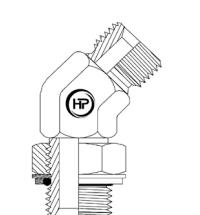

POA

**BSPTM X BSPPM(ADJ.)**  
45° ELBOW (M X M)

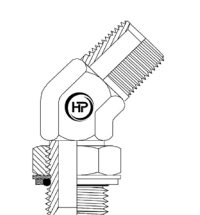

POA

**BSPTM X BSPTM**  
45° ELBOW (M X M)

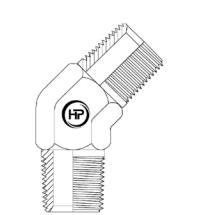

Page 48

**BSPTM X UNOM**  
45° ELBOW (M X M)

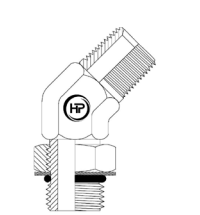

Page 48

**JICM X BSPPM**  
45° ELBOW (M X M)

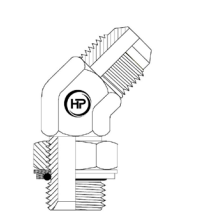

Page 47

For POA please contact us

Continued on the following page...



**JICM X BSPTM**  
45° ELBOW (M X M)

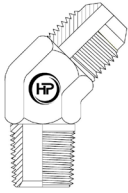

Page 47

**JICM X JICM**  
45° ELBOW (M X M)



POA

**JICM X NPTM**  
45° ELBOW (M X M)

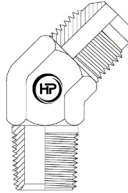

POA

**JICM X UNOM**  
45° ELBOW (M X M)

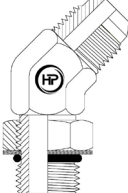

Page 48

**NPTM X NPTM**  
45° ELBOW (M X M)

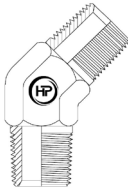

POA

**ORFSM X BSPPM(ADJ.)**  
45° ELBOW (M X M)

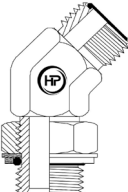

POA

**ORFSM X NPTM**  
45° ELBOW (M X M)

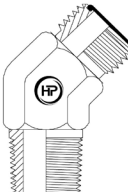

POA

**ORFSM X UNOM**  
45° ELBOW (M X M)

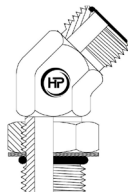

POA

**SAEM(45°) X BSPTM**  
45° ELBOW (M X M)

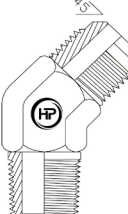

POA

**BSPTM X BSPTF**  
45° ELBOW (M X FS)

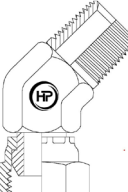

Page 50

**JICM X JICF**  
45° ELBOW (M X FS)

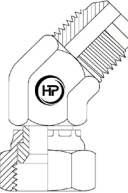

Page 49

**JICM X JICF**  
45° LONG BEND (M X FS)

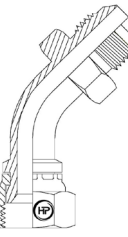

Page 49

**ORFSM X ORFSF**  
45° ELBOW (M X FS)

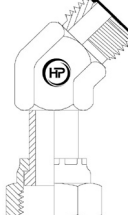

POA

**SAEM X SAEF (45°)**  
45° ELBOW (M X FS)

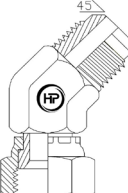

POA

**UNOM X JICF**  
45° ELBOW (M X FS)



POA

**BSPTM X BSPTF**  
45° ELBOW (M X FF)

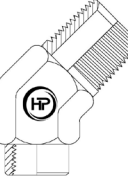

POA

**JICM X NPTF**  
45° ELBOW (M X FF)

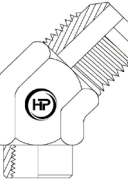

POA

**NPTM X NPTF**  
45° ELBOW (M X FF)

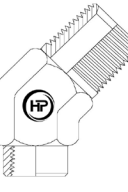

POA

**BSPTF X BSPTF**  
45° ELBOW (FF X FF)

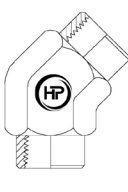

POA

**NPTF X NPTF**  
45° ELBOW (FF X FF)



POA

**Reducing Bush**

**BSPPM X BSPPF**  
REDUCING BUSH (M X F)

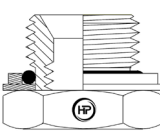

Page 51

**BSPTM X BSPTF**  
REDUCING BUSH (M X F)

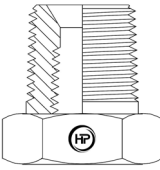

Page 50

**NPTM X NPTF**  
REDUCING BUSH (M X F)

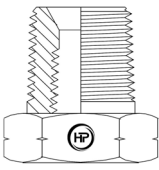

POA

**UNOM X BSPTF**  
REDUCING BUSH (M X F)



Page 51

**UNOM X UNOF**  
REDUCING BUSH (M X F)

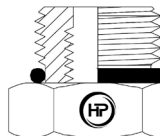

POA

For POA please contact us

# TEE - Run, Branch, Equal & Cross

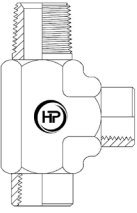
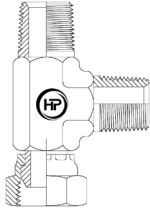
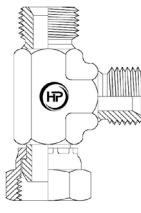
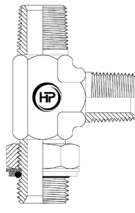
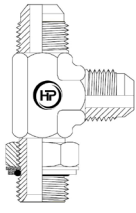
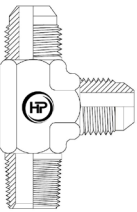
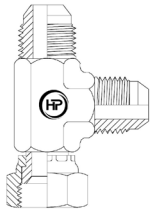
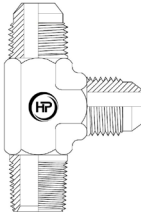
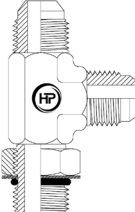
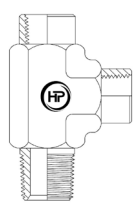
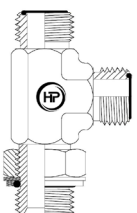
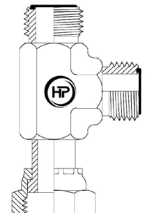
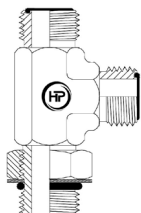
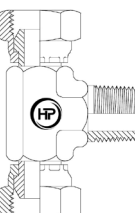
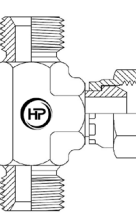
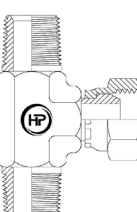
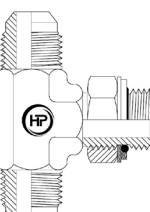
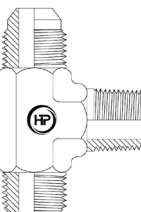
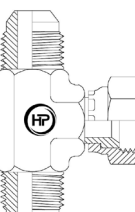
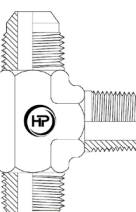
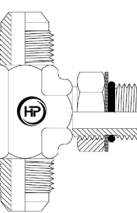
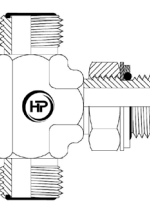
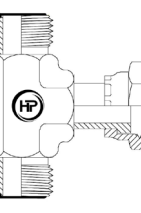
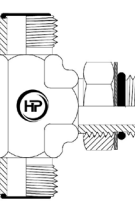
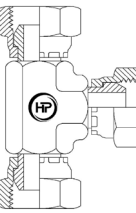
<p><b>BSPTM X BSPTF X BSPTF</b> RUN TEE</p>  <p>Page 55</p>	<p><b>BSPTM X BSPPF X BSPTM</b> RUN TEE</p>  <p>Page 54</p>	<p><b>BSPPM X BSPPF X BSPPM</b> RUN TEE</p>  <p>Page 54</p>	<p><b>BSPTM X BSPPM X BSPTM</b> RUN TEE</p>  <p>Page 54</p>	<p><b>JICM X BSPPM X JICM</b> RUN TEE</p>  <p>Page 53</p>
<p><b>JICM X BSPTM X JICM</b> RUN TEE</p>  <p>Page 53</p>	<p><b>JICM X JICF X JICM</b> RUN TEE</p>  <p>Page 54</p>	<p><b>JICM X NPTM X JICM</b> RUN TEE</p>  <p>POA</p>	<p><b>JICM X UNOM X JICM</b> RUN TEE</p>  <p>Page 53</p>	<p><b>NPTF X NPTF X NPTM</b> RUN TEE</p>  <p>POA</p>
<p><b>ORFSM X BSPPM X ORFSM</b> RUN TEE</p>  <p>POA</p>	<p><b>ORFSM X ORFSF X ORFSM</b> RUN TEE</p>  <p>POA</p>	<p><b>ORFSM X UNOM X ORFSM</b> RUN TEE</p>  <p>POA</p>	<p><b>BSPPF X BSPPF X BSPTM</b> BRANCH TEE</p>  <p>Page 57</p>	<p><b>BSPPM X BSPPM X BSPPF</b> BRANCH TEE</p>  <p>POA</p>
<p><b>BSPTM X BSPTM X BSPPF</b> BRANCH TEE</p>  <p>Page 57</p>	<p><b>JICM X JICM X BSPPM</b> BRANCH TEE</p>  <p>Page 55</p>	<p><b>JICM X JICM X BSPTM</b> BRANCH TEE</p>  <p>Page 56</p>	<p><b>JICM X JICM X JICF</b> BRANCH TEE</p>  <p>Page 56</p>	<p><b>JICM X JICM X NPTM</b> BRANCH TEE</p>  <p>POA</p>
<p><b>JICM X JICM X UNOM</b> BRANCH TEE</p>  <p>Page 56</p>	<p><b>ORFSM X ORFSM X BSPPM</b> BRANCH TEE</p>  <p>POA</p>	<p><b>ORFSM X ORFSM X ORFSF</b> BRANCH TEE</p>  <p>POA</p>	<p><b>ORFSM X ORFSM X UNOM</b> BRANCH TEE</p>  <p>POA</p>	<p><b>BSPPF X BSPPF X BSPPF</b> EQUAL TEE</p>  <p>Page 58</p>

For POA please contact us

Continued on the following page...

**BSPPF X BSPPF X BSPPF  
EQUAL TEE**

POA

**BSPTF X BSPTF X BSPTF  
EQUAL TEE**

Page 58

**BSPTM X BSPTM X BSPTM  
EQUAL TEE**

Page 58

**JICF X JICF X JICF  
EQUAL TEE**

POA

**JICM X JICM X JICM  
EQUAL TEE**

Page 57

**NPTF X NPTF X NPTF  
EQUAL TEE**

POA

**NPTM X NPTM X NPTM  
EQUAL TEE**

POA

**ORFSM X ORFSM X ORFSM  
EQUAL TEE**

POA

**BSPTF  
CROSS TEE**

POA

**JICM  
CROSS TEE**

POA

**Bulkhead - M x M**

**BSPPM  
STRAIGHT BULKHEAD (M X M)**

Page 60

**JICM  
STRAIGHT BULKHEAD (M X M)**

Page 60

**METRICM  
STRAIGHT BULKHEAD (M X M)**

POA

**ORFS  
STRAIGHT BULKHEAD (M X M)**

POA

**JICM(BH) X NPTM  
STRAIGHT BULKHEAD (M X M)**

POA

**JICM(BH) X BSPPM  
STRAIGHT BULKHEAD (M X M)**

POA

**JICM(BH) X BSPTM  
STRAIGHT BULKHEAD (M X M)**

POA

**JICM(BH) X BSPTF  
STRAIGHT BULKHEAD (M X FF)**

POA

**JICM(BH) X NPTF  
STRAIGHT BULKHEAD (M X FF)**

POA

**JICM  
90° BULKHEAD (M X M)**

Page 60

**ORFSM  
90° BULKHEAD (M X M)**

POA

**JICM  
45° BULKHEAD (M X M)**

Page 61

**ORFSM  
45° BULKHEAD (M X M)**

POA

**JICM X JICM(BH) X JICM  
TEE BULKHEAD (M X M X M)**

POA

**JICM X JICM X JICM(BH)  
TEE BULKHEAD (M X M X M)**

POA

For POA please contact us

Continued on the following page...

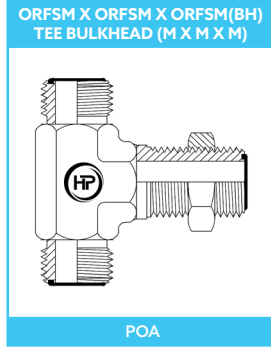
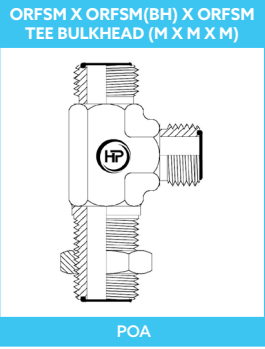

Nut + Sleeve & Plugs

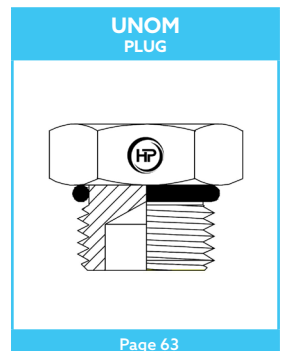
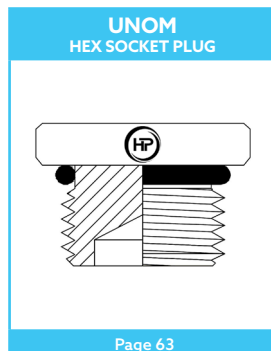
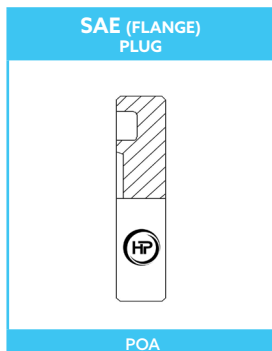
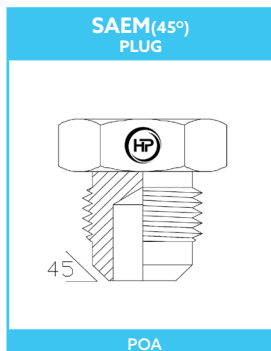
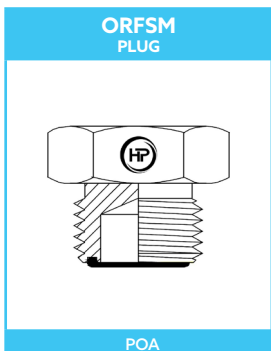
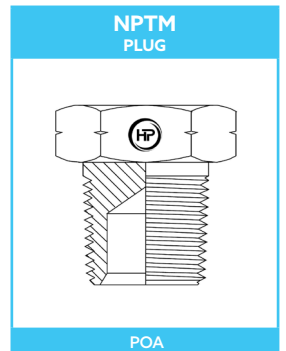
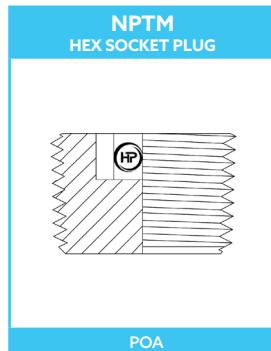
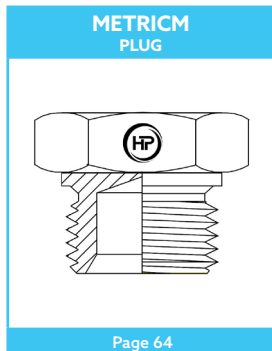
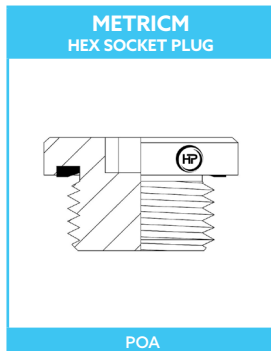
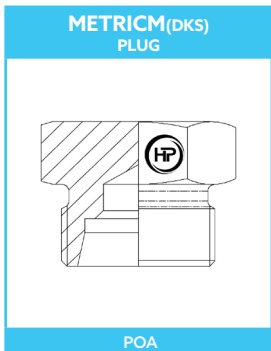
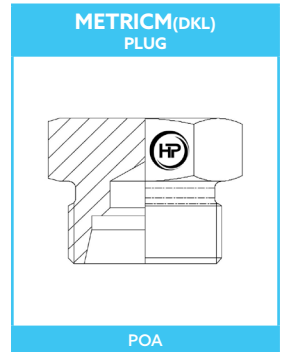
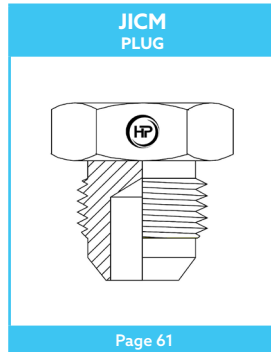
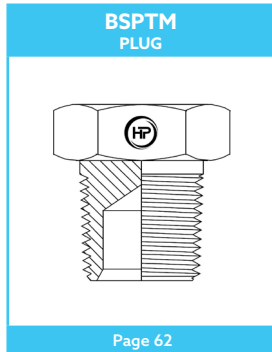
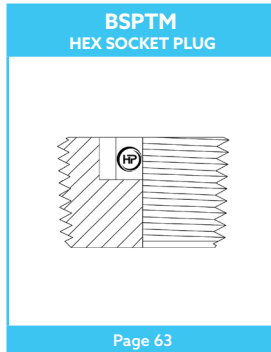
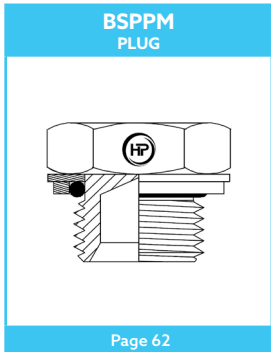
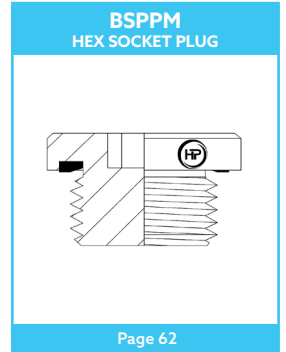
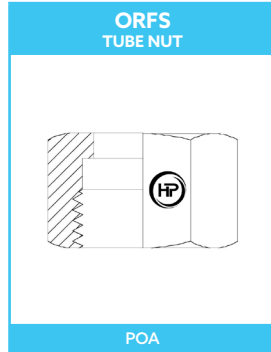
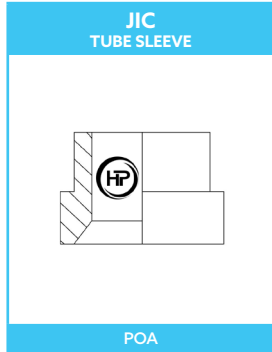
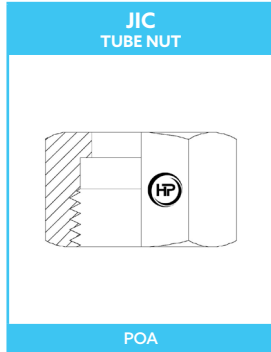
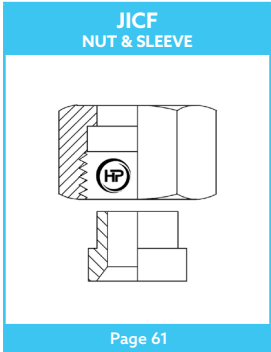

For POA please contact us

# Caps, Seals & Rings

<p><b>BSPP CAP</b></p> <p>POA</p>	<p><b>JIC CAP</b></p> <p>POA</p>	<p><b>METRIC CAP</b></p> <p>POA</p>	<p><b>NPT CAP</b></p> <p>POA</p>	<p><b>ORFS CAP</b></p> <p>POA</p>
<p><b>SAE (45°) CAP</b></p> <p>POA</p>	<p><b>BSPP BONDED SEAL</b></p> <p>Page 75</p>	<p><b>BSPP ENCAPSULATED SEAL</b></p> <p>Page 75</p>	<p><b>METRIC BONDED SEAL</b></p> <p>Page 74</p>	<p><b>METRIC ENCAPSULATED SEAL</b></p> <p>POA</p>
<p><b>BSPP ADJUSTABLE O' RING</b></p> <p>Page 75</p>	<p><b>BSPP RETAINING RING</b></p> <p>POA</p>	<p><b>ORFSM O' RING</b></p> <p>Page 76</p>	<p><b>SAE FLANGE O' RING</b></p> <p>Page 76</p>	<p><b>UNOM O' RING</b></p> <p>Page 76</p>

# SAE Flange



<p><b>CODE 61 CAP DOUBLE SIDED</b></p> <p>POA</p>	<p><b>CODE 62 CAP DOUBLE SIDED</b></p> <p>POA</p>	<p><b>CODE 61 ONE PIECE CLAMP</b></p> <p>POA</p>	<p><b>CODE 62 ONE PIECE CLAMP</b></p> <p>POA</p>	<p><b>CODE 61 PLUG</b></p> <p>POA</p>
<p><b>CODE 62 PLUG</b></p> <p>POA</p>	<p><b>CODE 61 SPLIT CLAMP</b></p> <p>POA</p>	<p><b>CODE 62 SPLIT CLAMP</b></p> <p>POA</p>	<p><b>JICM - CODE 61 45° SWEPT</b></p> <p>POA</p>	<p><b>JICM - CODE 62 45° SWEPT</b></p> <p>POA</p>

For POA please contact us

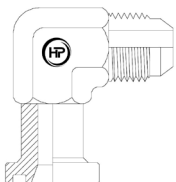
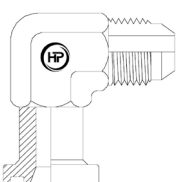
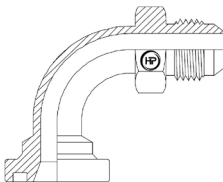
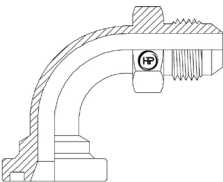
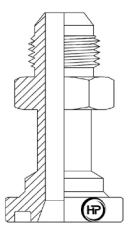
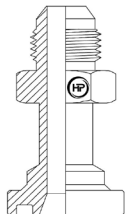
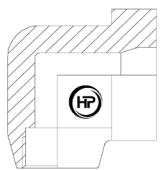
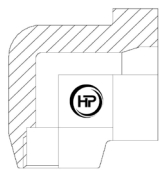
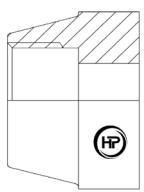
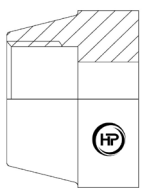
Continued on the following page...

<p>JICM - CODE 61 90° COMPACT</p>  <p>POA</p>	<p>JICM - CODE 62 90° COMPACT</p>  <p>POA</p>	<p>JICM - CODE 61 90° SWEPT</p>  <p>POA</p>	<p>JICM - CODE 62 90° SWEPT</p>  <p>POA</p>	<p>JICM - CODE 61 STRAIGHT</p>  <p>POA</p>
<p>JICM - CODE 62 STRAIGHT</p>  <p>POA</p>	<p>BSPPF (F) - CODE 61 90° COMPACT</p>  <p>POA</p>	<p>BSPPF (F) - CODE 61 90° COMPACT</p>  <p>POA</p>	<p>BSPPF (F) - CODE 61 STRAIGHT</p>  <p>POA</p>	<p>BSPPF (F) - CODE 61 STRAIGHT</p>  <p>POA</p>

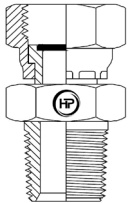
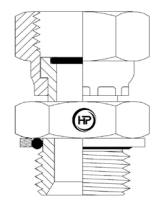
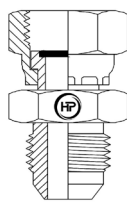
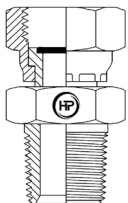
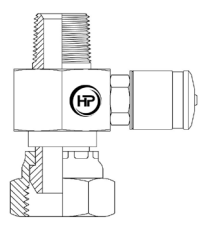
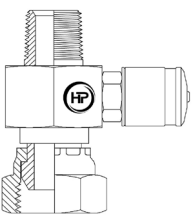
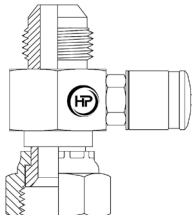
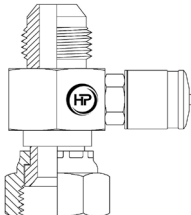
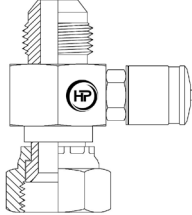
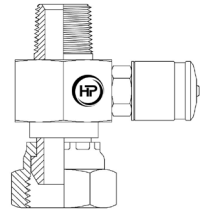
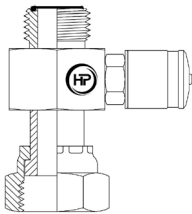
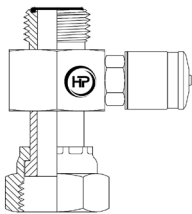
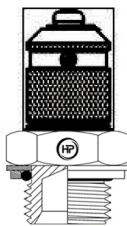
Guage Adaptor / Test Point

<p>BSPPF X BSPTM GUAGE ADAPTOR</p>  <p>POA</p>	<p>BSPPF X BSPPM GUAGE ADAPTOR</p>  <p>POA</p>	<p>BSPPF X JICM GUAGE ADAPTOR</p>  <p>POA</p>	<p>BSPPF X NPTM GUAGE ADAPTOR</p>  <p>POA</p>	<p>BSPTM X BSPPF X BSPPM CROSS PORT</p>  <p>POA</p>
<p>BSPTM X BSPPF X BSPTM CROSS PORT</p>  <p>POA</p>	<p>JICM X JICF X BSPPM CROSS PORT</p>  <p>POA</p>	<p>JICM X JICF X BSPTM CROSS PORT</p>  <p>POA</p>	<p>JICM X JICF X UNOM CROSS PORT</p>  <p>POA</p>	<p>ORFSM X ORFSF X BSPPM CROSS PORT</p>  <p>POA</p>
<p>ORFSM X ORFSF X BSPTM CROSS PORT</p>  <p>POA</p>	<p>ORFSM X ORFSF X UNOM CROSS PORT</p>  <p>POA</p>	<p>BSP TEST POINT</p>  <p>POA</p>	<p>UNO TEST POINT</p>  <p>POA</p>	<p>BSPT TEST POINT</p>  <p>POA</p>

For POA please contact us

**TECHNICAL  
INFORMATION**

# QUICK CONVERSION

## Pressure & Imperial to Metric

Pressure Conversion				
BAR	PSI	KPA	MPA	Kg/cm2
10	145	1000	1	10.2
20	290	2000	2	20.4
30	435	3000	3	30.6
40	580	4000	4	40.8
50	725	5000	5	51
60	870	6000	6	61.2
70	1015	7000	7	71.4
80	1160	8000	8	81.6
90	1305	9000	9	91.8
100	1450	10000	10	102
110	1595	11000	11	112.2
120	1740	12000	12	122.4
130	1885	13000	13	132.6
140	2030	14000	14	142.8
150	2175	15000	15	153
160	2320	16000	16	163.2
170	2465	17000	17	173.4
180	2610	18000	18	183.6
190	2755	19000	19	193.8
200	2900	20000	20	204
210	3045	21000	21	214.2
220	3190	22000	22	224.4
230	3335	23000	23	234.6
240	3480	24000	24	244.8
250	3625	25000	25	255
260	3770	26000	26	265.2
270	3915	27000	27	275.4
280	4060	28000	28	285.6
290	4205	29000	29	295.8
300	4350	30000	30	306
310	4495	31000	31	316.2
320	4640	32000	32	326.4
330	4785	33000	33	336.6
340	4930	34000	34	346.8
350	5075	35000	35	357
360	5220	36000	36	367.2
370	5365	37000	37	377.4
380	5510	38000	38	387.6
390	5655	39000	39	397.8
400	5800	40000	40	408
410	5945	41000	41	418.2
420	6090	42000	42	428.4
430	6235	43000	43	438.6
440	6380	44000	44	448.8
450	6525	45000	45	459
460	6670	46000	46	469.2
470	6815	47000	47	479.4
480	6960	48000	48	489.6
500	7250	50000	50	510

Imperial to Metric Conversion			
Dash size	Inch decimal	Inch fraction	MM
-1	0.06	1/16"	1.59
-2	0.13	1/8"	3.18
-3	0.19	3/16"	4.76
-4	0.25	1/4"	6.35
-5	0.31	5/16"	7.94
-6	0.38	3/8"	9.53
-7	0.44	7/16"	11.11
-8	0.50	1/2"	12.70
-9	0.56	9/16"	14.29
-10	0.63	5/8"	15.88
-11	0.69	11/16"	17.46
-12	0.75	3/4"	19.05
-13	0.81	13/16"	20.64
-14	0.88	7/8"	22.23
-15	0.94	15/16"	23.81
-16	1.00	1"	25.40
-17	1.06	1.1/16"	26.99
-18	1.13	1.1/8"	28.58
-19	1.19	1.3/16"	30.16
-20	1.25	1.1/4"	31.75
-21	1.31	1.5/16"	33.34
-22	1.38	1.3/8"	34.93
-23	1.44	1.7/16"	36.51
-24	1.50	1.1/2"	38.10
-25	1.56	1.9/16"	39.69
-26	1.63	1.5/8"	41.28
-27	1.69	1.11/16"	42.86
-28	1.75	1.3/4"	44.45
-29	1.81	1.13/16"	46.04
-30	1.88	1.7/8"	47.63
-31	1.94	1.15/16"	49.21
-32	2.00	2"	50.80
-33	2.06	2.1/16"	52.39
-34	2.13	2.1/8"	53.98
-35	2.19	2.3/16"	55.56
-36	2.25	2.1/4"	57.15
-37	2.31	2.5/16"	58.74
-38	2.38	2.3/8"	60.33
-39	2.44	2.7/16"	61.91
-40	2.50	2.1/2"	63.50



# PRESSURE DROP CHART

## Hose

The figures in the chart represent the approximate pressure drop in PSI per metre length of smooth bore hose excluding fittings

**Fluid specifications:** Viscosity Grade = ISO 46, Specific Gravity = 0.9, Absolute Viscosity = 41.4 at 40°C

Flow Rate		1/4"		3/8"		1/2"		5/8"		3/4"		1"		1.1/4"		1.1/2"		2"	
GPM	LPM	^P	(V)	^P	(V)	^P	(V)	^P	(V)	^P	(V)	^P	(V)	^P	(V)	^P	(V)	^P	(V)
2	7.6	19.0	(13.0)	3.82	(5.8)														
3	11.4	29.0	(19.6)	5.73	(8.7)	1.8	(4.9)												
5	18.9	53.0	(32.6)	9.5	(14.5)	3.0	(8.2)	0.9	(4.5)										
10	37.9			26	(29.0)	6.4	(16.3)	1.8	(9.0)	1.2	(7.2)								
15	56.8					13.5	(24.5)	3.1	(13.4)	1.8	(11.0)	0.6	(6.12)						
20	75.7					23.0	(32.7)	5.3	(17.9)	3.2	(14.5)	0.8	(8.2)						
25	94.6							8.0	(22.0)	4.2	(18.2)	1.2	(10.2)						
30	113.6							11.0	(27.0)	6.7	(21.8)	1.7	(12.3)	0.6	(7.8)				
40	151.4									11.8	(29.0)	2.8	(16.3)	1.0	(10.5)				
50	189.3											4.3	(20.4)	1.4	(13.0)				
60	227.1											6.0	(24.5)	2.0	(15.7)	0.8	(10.9)		
70	265.0											7.9	(28.6)	2.7	(18.3)	1.1	(12.7)	0.3	(7.1)
80	302.8											10.0	(32.7)	3.4	(20.9)	1.4	(14.5)	0.4	(8.2)
100	378.5													5.0	(26.0)	2.1	(18.0)	0.5	(10.2)
150	567.8															4.3	(27.2)	1.1	(15.3)
200	757.0																	1.8	(20.4)
300	1135.5																	3.7	(30.6)

^P = Pressure Drop in PSI  
V = Velocity in Ft/Sec

Example

**10m of 6G2**

Oil flow rate of 5 GPM = 9.5 (^P)

**m x P = Pressure Drop**

10 x 9.5 = 90.50m psi @ 5GPM

### FLOW RATE

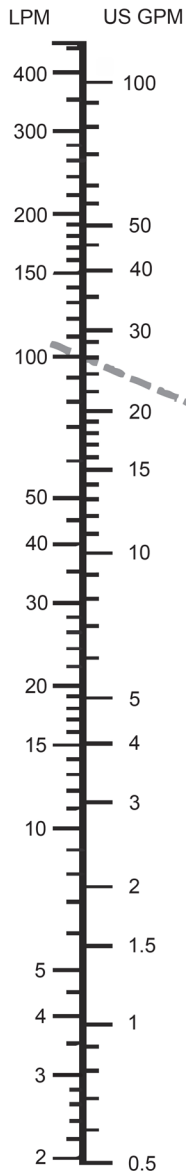

### HOSE BORE

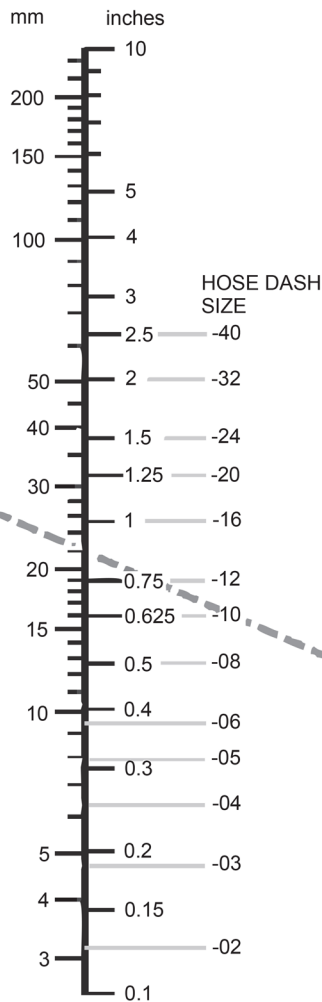

### FLOW VELOCITY

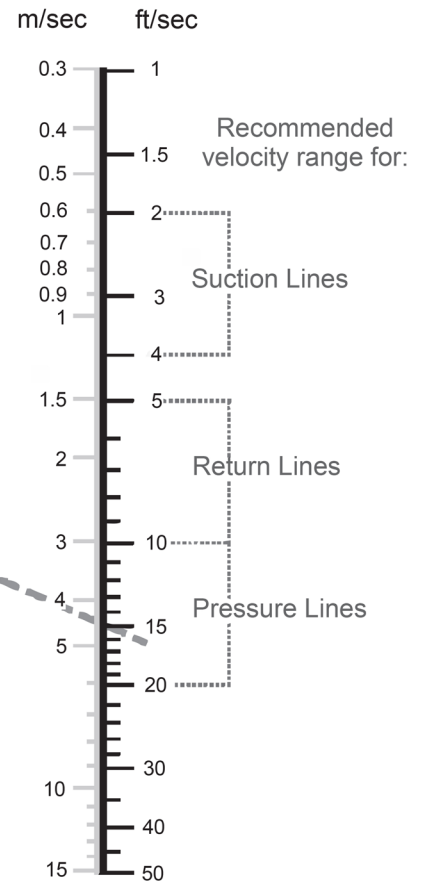

Using any two known factors lay a ruler across to find the value of the unknown factor line

### Hose Assembly Length

Unless otherwise specified, assembly length shall be the overall length measured from the extreme end of one connector to the extreme end of the other. Where elbow connectors are used, measurement shall be the centerline of the fitting.

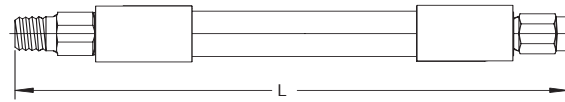

Straight connectors

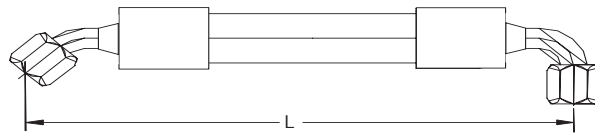

Female swivel elbow connectors

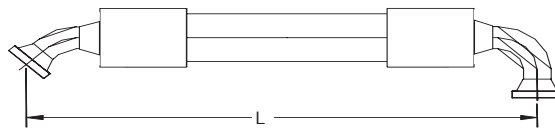

Flange connectors

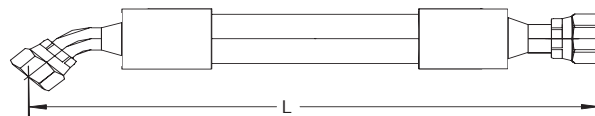

Straight and elbow connectors

### How to determine Angular Orientation

When a hose assembly has an elbow connection at each end, it will be necessary to check the offset position of the connections relative to each other.

This can be done by positioning the farthest connection vertically up (or down) and viewing the assembly in a line of sight position, the offset can then be measured in a clockwise direction through the centre of the farthest end to the centre of the nearest end.

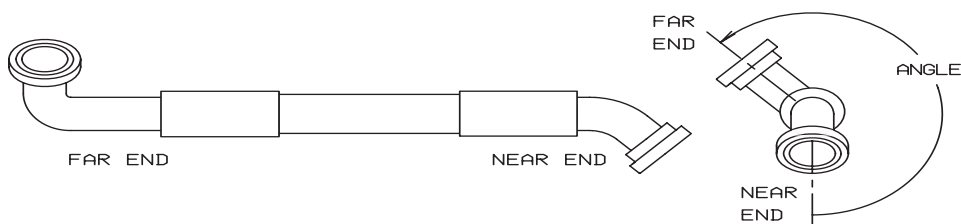

# CONNECTOR PRESSURE TABLES

## JIC, BSPP, BSPT, SAE

### IMPORTANT NOTICE

The pressures specified in this document are to be used as a guide only, not as a standard, specification or guaranteed minimum.

Many factors influence the pressure at which a system will operate. These factors include torque settings, alignment, vibration, external environment, correctness of installation, alignment, adequate support, temperature limits, pressures and pulses.

The Maximum Rated Working Pressure on an assembly or installation is the Maximum Rated Working Pressure of the component/connection with the least rating.

JIC				
Dash	Male		Female	
	Bar	PSI	Bar	PSI
07	480	7000	480	7000
08	480	7000	480	7000
09	345	5000	345	5000
12	275	4000	275	4000
14	260	3800	260	3800
17	240	3500	240	3300
21	225	3000	225	3500
26	170	2500	170	2500
30	145	2100	145	2100
40	120	1750	120	1750

BSPP						
DASH	Male - Encapsulated		Male Adjustable		Female - Swivel	
	Bar	PSI	Bar	PSI	Bar	PSI
02	600	8700	275	4000	550	8000
04	600	8700	275	4000	550	8000
06	600	8700	275	4000	520	7500
08	400	6000	275	4000	380	5500
12	400	6000	170	2500	275	4000
16	400	6000	170	2500	240	3500
20	380	5500	140	2000	200	3000
24	380	5500	140	2000	175	2500
32	250	3500			140	2000

### BSPT

Dash	Male - Fixed		Male - Swivel		Female - Fixed	
	Bar	PSI	Bar	PSI	Bar	
02	690	10000			550	
04	650	9500	260	3750	550	
06	550	8000	200	3000	520	
08	410	6000	170	2500	380	
10	340	5000	170	2500	275	
12	340	5000	170	2500	275	
16	275	4000			240	
20	200	3000			200	
24	140	2000			175	
32	140	2000			140	

### NPT

Dash	Male - Fixed		Male - Swivel		Female - Fixed	
	Bar	PSI	Bar	PSI	Bar	PSI
02	690	10000			550	8000
04	650	9500	260	3750	550	8000
06	550	8000	200	3000	520	7500
08	410	6000	170	2500	380	5500
12	340	5000	170	2500	275	4000
16	275	4000			240	3500
20	200	3000			200	3000
24	140	2000			175	2500
32	140	2000			140	2000

### SAE

Dash	CD61		CD62	
	Bar	PSI	Bar	PSI
08	345	5000	410	6000
12	345	5000	410	6000
16	345	5000	410	6000
20	275	4000	410	6000
24	205	3000	410	6000
32	205	3000	410	6000

### JIS

Dash	Male		Female	
	Bar	PSI	Bar	PSI
14 (M)	450	6500	410	6000
16 (M)	450	6500	410	6000
22 (M)	410	6000	380	5500
24 (M)	345	5000	310	4500
30 (M)	275	4000	260	3750

# CRIMP CHARTS

## Hose

### One Wire

R1AT 1SN		One Piece	Two Piece
Dash	Size	mm	mm
04	1/4"	17.3	18.4
05	5/16"		19.5
06	3/8"	21.5	21.6
08	1/2"	25	23.6
10	5/8"	28.3	27.2
12	3/4"	31.8	30.8
16	1"	40.5	39.4

### Two Wire

R2AT 2SN		One Piece	Two Piece
Dash	Size	mm	mm
04	1/4"	18.3	19.4
05	5/16"	19.8	20.5
06	3/8"	22.5	22.2
08	1/2"	26.0	24.6
10	5/8"	29.2	28.2
12	3/4"	32.7	31.8
16	1"	41.5	40.4

## QUALITY

With **HYDPOWER'S** Hose & fittings range you can be rest assured that all of our products listed in this catalogue have been thoroughly tested within the performance parameters of the relevant hose types we supply. To obtain optimum performance from our hose & fittings, all connections should be made in accordance with any technical data we produce. All our products are manufactured to global industry standards and come with an industry leading 24 month no quibble warranty.

## COMPATIBILITY

It is important to not mix & match hydraulic hose supplied by us with fittings from another manufacturer. It is the responsibility of the hose assembly fabricator to consult the manufacturers assembly instructions before intermixing hose & fittings from two different manufacturers. We accept no responsibility if these guidelines are not followed.

## DISTRIBUTION

We understand that when you order products from us, you need them quickly. We pride ourself on our accurate product selection and timely distribution. We will pick your parts right first time and get them out to you as fast as possible using our shipping & courier network. Our comprehensive ordering & despatch system ensures that your orders are correct before leaving us.

## WHAT YOU CAN EXPECT

**Differentiation** - Both product manufacture and quality control are under direct and daily supervision of first class team here in Australia. All products are checked and packed in our factory before being shipped directly to you.

**Logistics Support** - We are experts in receiving, breaking down shipments and on-forwarding customer orders to the point of supply. This minimises logistic costs, handling points and lead time for you.

**Supply chain connection** - With our advanced, in house developed cloud-based logistics system, we're able to interact with you directly, taking care of the complete supply chain process from start to finish.

**Cost-effective convenience** - You have the advantage of dealing with a quality supplier at a low-cost base. The efficiency of our supply chain processes adds to the cost effectiveness.

**Peace of mind** - Our aim is to save you time, money and stress. We deal with all the detail associated with supply (quality control, importing, minimum order quantities and more) while providing seamless communication with you. The process is effortless for you and gives you the security and convenience of dealing with a wholly owned Australian company. It frees you up to do what you do best.

Contact us today to find out how **HYDPOWER** can work with your company to supply and deliver quality products.

## DISCLAIMER

We reserve the right to alter the design or discontinue any of the company's products or services without notice. Whilst every effort has been made to ensure the accuracy of the information in this catalogue, it may be necessary to make changes that aren't reflected in this publication. All illustrations are not to scale and are indicative of type only.

© Hydropower Hydraulics 2022

# TERMS & CONDITIONS

**STANDARD CONDITIONS OF SALE** "Hydpower Hydraulics" means Hydpower Hydraulics Pty Ltd A.B.N 38 114 349 245 and all related corporations, successors and assigns;

"Contract" means the contract referred to in Clause 2;

"Customer" means a person or entity acquiring or offering to acquire Products from Hydpower Hydraulics and, where the Customer comprises more than one party, the covenants and obligations of each party are joint and several;

"Products" mean all products, services and equipment supplied or to be supplied by Hydpower Hydraulics to the Customer;

"Conditions" means these Standard Conditions of Sale.

## 1. APPLICATION OF CONDITIONS

Unless otherwise agreed in writing by Hydpower Hydraulics, these Conditions will apply to all quotations, orders and offers in relation to the Products and the sale, supply, service and replacement of all Products and will take precedence over any inconsistent provisions in any Customer order or contained or referred to elsewhere or implied by trade custom, practice or course of dealing.

## 2. ORDERS AND CONTRACT

2.1 Each order by a Customer is deemed to be an offer to the Company under these Conditions and is not binding on Hydpower Hydraulics prior to Hydpower Hydraulics acceptance of it. On Hydpower Hydraulics written acceptance of an order, the order and these Conditions will constitute the entire agreement of the parties in relation to the subject of that order (the "Contract") and may only be varied in writing, signed by the parties.

2.2 Acceptance by the Customer of possession and/or delivery of Products will constitute acceptance or confirmation of previous acceptance of these Conditions to be exclusion of all other terms or provisions.

2.3 The Customer is not entitled to cancel any order or materially vary any specifications without Hydpower Hydraulics previous consent in writing.

## 3. QUOTATIONS AND PRICES

3.1 Prices quoted by Hydpower Hydraulics are firm for a period of 28 days from the date of quotation.

3.2 Hydpower Hydraulics reserves the right to make any changes necessary to correct errors or allow for increases in the cost of labour, materials, freight, foreign exchange rates, taxes, duty or other levies taking effect prior to the date of delivery.

3.3 Unless otherwise stipulated, the quoted price is exclusive of all taxes and duties, transit insurance and transportation costs and charges of any other kind, for which the Customer will also be liable.

## 4. CREDIT

Hydpower Hydraulics reserves the right to withdraw credit at any time and substitute cash with order or cash on delivery or any other terms. Hydpower Hydraulics may refuse to proceed with any Contract at any time if the Customer's credit is/or becomes unsatisfactory to Hydpower Hydraulics.

## 5. DESCRIPTION

5.1 Hydpower Hydraulics catalogues, price lists and quotations do not constitute offers. Any description of Products given by Hydpower Hydraulics is for identification purposes only and does not constitute the Contract of sale by description.

5.2 All drawings, designs, specifications and particulars of weight, dimensions and any figures or statements as to the performance of the Products issued by Hydpower Hydraulics are intended merely to describe the Products generally and are not to be regarded as warranty, representation or contractual term unless expressly agreed by Hydpower Hydraulics in writing.

## 6. TITLE AND RISK

6.1 Notwithstanding any arrangements made for the transportation of the Products to the Customer's nominated destination, all Products sold are at the risk of the Customer from the time the Products leave Hydpower Hydraulics premises.

6.2 Regardless of the point at which risk in the Products passes to the Customer, Products remain the property of the Company as legal and equitable owner and no property in or title to any Products supplied with pass to the Customer until payment has been made (and all cheques and other negotiable instruments have been cleared) for all Products supplied by Hydpower Hydraulics to the Customer. Pending legal and beneficial ownership of the Products passing to the Customer, the Customer must: - 1. Keep the Products in good condition; 2. keep the Products fully insured to their full replacement value against all risks; 3. not encumber the Products in any way; and iv. hold and keep the Products separately from other property in the possession of the Customer in a manner which enables the products to be easily identifiable as Products supplied by Hydpower Hydraulics.

6.3 Failure to make any payment to Hydpower Hydraulics by the due date will, without prejudice to any other available remedies, entitle Hydpower Hydraulics to repossess the Products from any premises where they may be situated. For the purpose of repossessing the Products, the customer hereby grants and irrevocable licence to Hydpower Hydraulics, its employees or agents, to enter upon such premises as Hydpower Hydraulics reasonable suspects the Products may be located, using such reasonable force as is necessary and the Customer will indemnify the Company from and against any liability to any third party in respect of any such damage and from and against all actions, proceedings, claims, demands, costs, damages and expenses howsoever arising.

6.4 Hydpower Hydraulics will be entitled to bring an action against the Customer for the price of the Products in the event of non-payment by the Customer by the due date as if the property in the Products had already passed to the Customer and will also have the right by notice in writing to the Customer at any time after the agreed delivery date to pass the property in the Products to the Customer as from the date of such notice.

## 7. CLAIMS

7.1 Return of Products will not be accepted unless: - 1. Hydpower Hydraulics has received a substantiated written claim within 14 days from the date of delivery; 2. Prior authorisation has been given by the Company; 3. On return, the Products are accompanied by appropriate documentation which stipulates the invoice number, the Customer name and address and the reasons for return; iv. The Products are faulty by reason only that the quality of materials used for the construction of the Products or the manufacturing process was defective.

For comprehensive details please see our website for details.







contact the **HYDPOWER** team today  
**P:** 1300 730 198 | (03) 5975 0885  
**E:** [sales@hydpower.com.au](mailto:sales@hydpower.com.au)  
**W:** [hydraulicfittings.com.au](http://hydraulicfittings.com.au)  
**A:** 2/9 Fuji Cres, Mornington, Vic, 3931